

K-900

2CH DASH CAMERA
(LCD + ADAS + Wi-Fi)

Manual Ver 1.0

- ※ Some of the functions and GUI in this User's Guide can be different depending on the installed firmware version.
- ※ ADAS icon will appear on the LCD screen when GPS signal is stable.
- ※ ADAS feature is available only when GPS is installed. When GPS signal is weak, ADAS will function under the P mode (Pseudo Speed). However the accuracy of ADAS information can be decreased.
- ※ The manufacturer is not held responsible for any damage that may arise due to incorrect operation of ADAS.
- ※ The accuracy of ADAS information may vary due to changing road and weather conditions. Please use the information for reference purposes only.
- ※ Lukas App can be downloaded from Google Play Store, and the App Store.
- ※ OS versions required for Lukas App: Android 4.0 or higher, iOS 5.0 or higher.
- ※ Wi-Fi can be unstable or disconnected depending on surrounding environments and types of smart devices used for connection.
- ※ Information on Lukas App contained in this User Guide can be different from the one installed on the user's smart device depending on the application version.
- ※ With the Format-Free function, the memory card needs to be formatted after changing settings.
- ※ With the Format-Free function, the memory card efficiency can be affected.
- ※ With the Format-Free function, old video files can be played when using other media players (e.g. Window Media Player)
- ※ When recorded in low light conditions, video image may contain some noise.



[Download the Lukas App
on Google Play]



[Download the Lukas APP
on Apple App Store]

Thank you for choosing Lukas Dash Camera.

This User Guide is for the users of K-900.
The User Guide may contain technical errors and/or omissions.
For the latest and updated User Guide & Firmware, visit our website www.lukashd.com.

■ Read Carefully Before Using This Device ■

- ※ Before using your Lukas dash camera, please read through this User Guide to ensure the correct use of the device.
- ※ Qrontech Co., Ltd. reserves all rights to this User Guide in accordance with the copyright law.
- ※ The contents of this User Guide are subject to change without prior notice to improve the performance of the device.
- ※ Some functions may or may not be available depending on the installed firmware version.
- ※ This device is designed to help safe driving. In the event of an accident, the driver must take full responsibility. Please use this device accordingly.

■ Scope of Guarantee and Responsibility ■

- ※ This device records videos and sounds to provide visual proof of a vehicular accident. However, it does not guarantee video recording of all accidents.
- ※ The manufacturer is not responsible for the loss of any files or data due to a malfunction of the device.
- ※ A memory card in general is a consumable item with a limited lifespan, and data can be lost due to external voltages and/or static electricity existing in the user's surrounding environment. For this reason, it is highly recommended that you back up important video files using other media devices.
- ※ Although this device has Format-Free function, a memory card may obtain corrupt video files (omissions & cuts in recording, changes in frame rates, etc.) due to a decrease in reading and writing speed as it reaches the end of its lifespan. Please use genuine Lukas memory cards and format them on a regular basis (Once a month for an 8GB SD card.)
- ※ This is an auxiliary device that records audio and video footage. However, it does not guarantee video recording of all accidents as users' environments vary. Please use this device for reference purposes only.
- ※ The manufacturer is not responsible for any problems caused by using this device in Parking Mode recording without an extra battery pack to power the device while car ignition is off.
- ※ The accuracy of ADAS data can vary depending on the user's environment. It is recommended that you use ADAS information for reference purposes only.
- ※ The manufacturer is not responsible for any physical or mental damage caused by an accident due to malfunctioning of ADAS.

CONTENTS

1. Instructions For Use

1-1. Precautions and Notices	4
1-2. Installation	6
1-3. GPS	6
1-4. Memory Card	7
1-5. ADAS	8

2. Features

3. Device Overview

3-1. In the Package	11
3-2. Names & Functions of Each Part	12

4. Installation

4-1. Before Installation	13
4-2. Step-by-Step Installation Guide	13
4-3. How to Hardwire Continuous Power Cable	15
4-4. How to Adjust Camera Angle	16
4-5. Memory Card Recording Time	17

5. Device Operations

6. How to Use Lukas Dash Cam

6-1. Getting Started	22
6-2. Parking Surveillance Notice	23
6-3. Home Menu	24
6-4. Real-Time Video	25
6-5. Playback	26
6-6. Settings	28
6-7. Memory Card Format	36
6-8. ADAS Guide	37
6-9. Time Setting	38

7. Lukas Application

7-1. Getting Started with Lukas App	39
7-2. Connecting to Lukas App	39
7-3. How to Use Lukas App	40

8. Lukas Viewer

9. Specifications

# Quality Assurance	49
---------------------	----

1. Instructions For Use

■ 1-1. Precautions and Notices ■

- 1. Do not expose the device under direct sunlight or in extremely cold conditions for an extended period of time.**
Direct exposures to extreme temperatures may damage the device. When the device is not in operation, make sure the temperature stays within the storage temperatures. The exterior of the device may change in color when exposed to direct sunlight for a prolonged period of time.
- 2. Do not disassemble, repair, or modify the device.**
Do not attempt to disassemble, modify or repair the device. Warranty cover will be void if a repair has been attempted by the user or anyone unauthorized.
- 3. Do not modify and cut the power cable.**
Modifying or cutting the power cable can damage the device and the vehicle. The manufacturer is not responsible for any damages as a result of such modifications.
- 4. Do not operate the device with wet hands. Also, avoid any liquid getting into the device, and do not leave the device in overly humid environments.**
When cleaning the device, do not use water, chemicals or liquid detergent. Please use a soft and dry cloth.
- 5. Avoid heavy impacts and foreign objects to the device.**
Excessive impacts to this device can cause malfunction. Handle the device with care.
- 6. Only use Lukas branded genuine accessories provided by the manufacturer.**
It is highly recommended to use genuine accessories that are tested safe and compatible with Lukas dash cameras. Users must take full responsibility for any problems caused by using third-party accessories not provided by the manufacturer.
- 7. Compatibility is not guaranteed when using third-party devices and peripherals.**
Users must take full responsibility for any damage as a result of using such devices and peripherals.
- 8. Do not use the device when the vehicle ignition is off for an extended period of time.**
Using the device for an extended period of time when the vehicle ignition is off can result in battery drainage.
- 9. Extreme changes in surrounding brightness can affect image quality.**
When there is too much backlighting or when the level of surrounding brightness changes dramatically, for example when entering and leaving a tunnel, the quality of video image can be lowered.
- 10. Disconnecting the power cable while the device is in operation or using an incorrect input voltage can damage the device or cause a fire.**
- 11. Some PCs may not support Lukas Viewer, or there may be some disconnections in audio and image depending on PC specifications.**

12. Subtle impacts may not be strong enough to start Event Recording.

Light impacts may not be detected for Event Recording depending on the users' settings. Also if strong impact disconnects power supply to the device, Event Recording may not be saved.

13. Videos recorded in low light may contain noise and videos may shutter due to vibrations when your vehicle is stopped or idling.

14. There may be loss of data with a sudden frame rate drop, or when switching between Parking and Driving Mode Recordings.

15. Motion detections may malfunction in certain conditions depending on the amount of light, weather conditions and other surrounding environments. This can result in motions being detected continuously.

16. Parking in low-light areas such as underground parking lots may result in incorrect operation of Motion Detection recording due to low-light noise and reflections of Security LED.

17. Due to the characteristics of wide-angle lens on the device, the left and right-side image quality can be different.

18. Due to the characteristics of wide-angle lens on the device, the left and right-side image quality can be different.

19. Do not press the surface of the LCD screen using a pointed object may damage the touchscreen panel.

20. Rear view videos may not be saved correctly if the connection between front and rear camera is unstable.

21. Selecting Time Lapse function in Parking Mode Recording disables Motion Detection function.

22. Only one smartphone can be connected to a Lukas dash camera at once, and once connected, use of the Internet can be restricted.

23. Depending on smartphone models and OS versions, playback and some other functions may not be supported.

24. The range of Wi-Fi signal may vary depending on user and network environments.

25. When connected to Wi-Fi for playback, the device stops recording and resumes after Wi-Fi is disconnected.

26. It is not recommended to record continuously in Parking Mode.

If you wish to record continuously when the vehicle is parked, it is recommended to install an extra battery pack. The user must take full responsibility if the vehicle battery drains as a result of continuous recording in Parking Mode without an extra battery pack.

27. If you suspect any malfunction of the device, stop using the device and contact your local distributor, or Lukas Customer Support (support@qrontech.com).

Continued use of the device after signs of malfunction can further damage the device, and some of the customer services can be restricted.

■ 1-2. Installation ■

1. Keep the surrounding of the device clear.

Dashboard reflections can cause parts of the video images difficult to distinguish. Avoid placing objects on the dashboard.

2. Keep the camera lens clean at all times.

3. Do not install or operate the device while driving.

For your safety, do not install or operate the device while driving to avoid an accident.

4. Keep the device securely mounted at all times.

The device can fall and be damaged if it is not securely mounted as instructed in the User Guide.

5. Video footage can be indistinct or look distorted if the windshield is heavily tinted.

6. Please install the device distant from other GPS devices (Radio, CD/MP3 players etc.)

Electromagnetic waves from the dash camera can affect other in-car GPS units (Radio, CD/MP3 players etc.)

■ 1-3. GPS ■

1. A typical GPS receiver achieves an accuracy of 15 meters. There may be conditions where GPS signals cannot be received depending on the driving environments such as tunnels, underpasses, skyscrapers, and street light which affect the accuracy level.

2. It may take some time to receive GPS signal for the first time after power is turned on depending on weather and other surrounding conditions.

3. Excessive tinting and other electronic devices can interrupt receiving GPS signal.

4. When the vehicle is at a stop, driving speed may display between the 1~30km/h range depending on the GPS reception status.

5. GPS data can be lost if the device is off.

6. Time on the device may not be accurate if the device does not have GPS.

■ 1-4. Memory Card ■

1. Do not remove the memory card while the device is recording.

Make sure the device is completely turned off before removing the memory card. Removing the card when the power is on can damage the video files, the memory card and the device.

2. Please format your memory card at least once a month (for 8GB).

As a dash camera continuously writes and deletes files on the memory card, the card and the files can be damaged. Formatting your memory card on a regular basis can prevent such damages. Also a memory card is a consumable item which can only last for about six month on average. Users must take full responsibility for any loss of data or recording problems as result of using a memory card after prolonged use.

3. Please use Lukas branded memory cards supplied by the manufacturer.

Users must take full responsibility for any problems caused as a result of using a third-party memory card.

4. Be careful when inserting and removing the memory card from the device to avoid burns.

A memory card operates at very high temperatures. Be careful when handling the cards.

5. The range of operating temperatures may vary depending on the performance of a memory card.

6. Back up video files on the memory card to another storage device (e.g. PC, external hard drive) to prevent loss of important data.

7. Memory card format is required after changing some of the recording settings such as video quality and memory card settings.

8. No firmware updates or configuration settings is needed after formatting memory cards.

Users' latest settings is saved on the device, and re-setting the device is not required after the format is complete.

9. Please format your memory card directly from the device.

The memory card does not need to be removed from the device for formatting on a PC. Please format your memory card using the format function on the device.

10. Make sure a microSD card is inserted in the device. Without it, the device does not start recording.

11. The device has Format-Free function and the device may malfunction if unsupported files are copied to, moved or deleted from the memory card.

12. When formatting a memory card on a PC, it is recommended that you opt for the full format option rather than the quick format option.

■ 1–5. ADAS (Advanced Driver Assistance System) ■

1. ADAS is available only on a GPS-enabled device.
2. For Auto-Calibration of ADAS, please follow the instructions.
3. LDWS (Lane Departure Warning System) may not function normally when driving in the rain at night, in the snow and in extreme road conditions.
4. ADAS may not function normally if the dash camera is relocated on the windshield or if the angle of camera lens is adjusted after the calibration is complete.
5. If relocated or the angle is adjusted, please turn off and on the device again for calibration.
6. Conditions for Calibration (when selected as Auto-calibration).
 - ※ When set to Auto-Calibration (Auto-Calibration ON).
 - Dash Camera is powered on.
 - GPS signal is acquired and stable.
 - Drive for about 3 minutes at a speed higher than 30km/h.
 - ※ When set to Manual Calibration (Auto-Calibration OFF).
 - Ready when dashcam powers on.
7. ADAS may not function normally when driving through areas where GPS signal cannot be acquired.
8. Please use ADAS information for reference purposes only. The manufacturer is not responsible for any road accidents as a result of incorrect operation of ADAS.
 - ※ ADAS information can have errors depending on varying users' environments. Please use the data for reference purposes only.
 - ※ Auto-Calibration setting can be turned on/off in settings (Settings > ADAS)

2. Features

▶ High-Clarity Video Quality

Front Camera : 5.48M Effective Pixels (1/2.9") **Sony Exmor R IMX326 STARVIS Sensor**

Rear Camera : 2.13M Effective Pixels (1/2.9") **Sony Full HD Sensor**

▶ Distortion-Free Recording with Wide-Angle Lens

Front Camera : **2560X1440p QHD Recording at max. 30fps**

(Diagonal: approx. 120° / Effective Viewing Angle: Horizontal approx. 103°, Vertical approx. 53°)

Rear Camera : **1920X1080p Digital Full HD Recording at max. 30fps**

(Diagonal approx. 125° / Effective Viewing Angle : Horizontal approx. 105°, Vertical approx. 54°)

▶ 3.5inch IPS LCD(320X480) + Full Touch

▶ Supports ADAS

– Lane Departure Warning System (LDWS), Front Collision Warning System(FCWS), Front Car Moving Detection (FCMD)

– Auto-Calibration

▶ Supports Wi-Fi, 2nd Monitor, Vibrator

▶ Night Vision – Improved night image quality

▶ Time Lapse Recording – Supports continuous recording in Parking Mode Recording

▶ Supports Format-Free function & Wi-Fi (802.11b/g/n (2.4~2.4835GHz))

▶ Various Recording Modes

– Continuous Recording : Continuously records 3-minute videos

– Event Recording : Records before & after impact detected for 30 seconds in total

– Manual Recording : Records when 'E' button is pressed during Continuous Recording

– Motion Detection Recording : Records when motion is detected in Parking Mode

– Time Lapse Recording : Captures one frame per second for continuous recording in Parking Mode

▶ Built-in Low-Voltage Cut-Off Function – Supports Multi-Booting System Leakage Current less than 100uA

▶ Dual Save (Continuous + Event / Motion + Event)

- ▶ **microSD Card up to 512GB**
- ▶ **Supports Multiple Languages**
 - GUI : Korean, English, Japanese, Chinese
 - Voice Guidance in 21 languages : English, Korean, French, Latin American Spanish, European Spanish, Arabic, Chinese, Russian, Japanese, Thai, Bahasa Indonesia, Mongolian, Vietnamese, Malay, German, Turkish, Italian, Hindi, Cantonese, Czech, Portuguese
- ▶ **Built-in Dual Band (GPS+GLONASS)**
- ▶ **Dual Security LED**
- ▶ **Operating Temperatures : -30°C ~ 80°C (-22°F ~ 176°F)**
- ▶ **Mounting Bracket & Hardwiring Kit Included**
- ▶ **No interruption with electric rear window sunshade by minimizing the height of the rear camera.**
- ▶ **Stores 2 million driving information data**
- ▶ **Parking Surveillance Notice**
 - Notice for Motion and Event detections during Parking Mode Recording before switching back to Driving Mode.
- ▶ **Built-in Microphone** – Records image and audio simultaneously
- ▶ **Direct Format on the dash camera** – Format your memory card directly from the dash camera or using Lukas Mobile Application.
- ▶ **Built-in Super Capacitor**
 - An internal battery replacement is not necessary with a built-in semi-permanent super capacitor. When the device power cuts off, super capacitor manages to write the last recording file onto the memory card.
- ▶ **Video Playback**
 - Watch recorded videos directly on the LCD screen of the dash camera, or on Lukas Mobile Application and PC Viewer. Third-party viewer programs can also be used.
- ▶ **Firmware Upgrade** – Firmware will be upgraded to enhance performance and to correct errors.
- ▶ **Configuration Settings** – Users can customize the dash camera settings.

3. Device Overview

3-1. In the Package

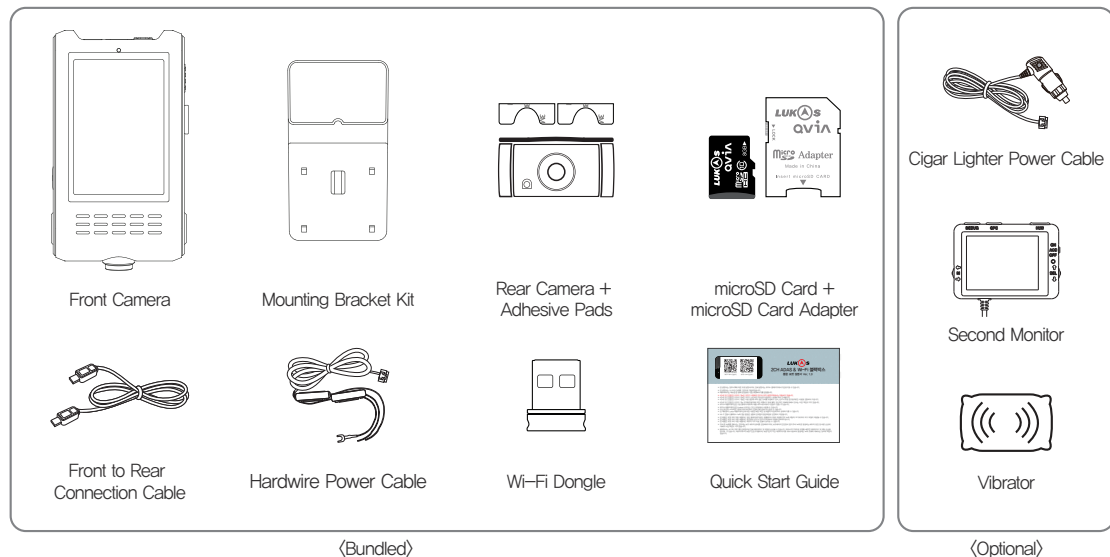

- ※ Make sure you have all the bundled items above.
- ※ Please use genuine Lukas accessories.

3-2. Names & Functions of Each Part

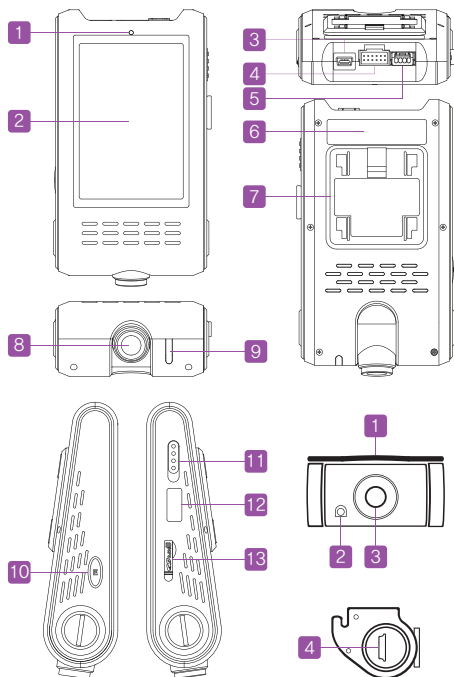

	Name	Function
1	Operating Status LED	Indicates dash camera operating status
2	LCD & Touch	Displays real-time video, playback and user settings
3	CAM-IN	Connection of the rear camera
4	DC-IN	Power supply to dash camera
5	2nd Monitor	Connection of the 2nd monitor
6	Serial Number	Model Name & Serial Number
7	Mount	For Mounting bracket
8	Camera Lens	Video signal input
9	Security LED	Displays dash camera's operating status, Indication of recording modes.
10	Emergency Recording (E) Button	Manual recording when pressing this button. (Generates 30-second file in Event folder) ※ Press for longer than 3 seconds for touchscreen calibration.
11	Power Switch	Power supply switch (ON/ACC/OFF)
12	Wi-Fi	Wi-Fi Dongle
13	microSD slot	Slot for microSD card

	Name	Function
1	Mount	Attach this part on the rear window
2	Security LED	Displays dash camera's operating status, Indication of recording modes.
3	Camera Lens	Video signal input
4	Rear Cable Connection	Connection of the rear camera

4. Installation

4-1. Before Installation

- ※ Before installation, please park the vehicle on a level surface and bright area. Turn off the engine and remove the key.
(Make sure the parking brake is ON)
- ※ Pick a spot for the device behind or near the rear view mirror, so that there is no obstruction to a driver's vision.
- ※ Installing the device facing too high (camera lens) can cause some of the functions to malfunction
(Weak GPS signal, continuous event recording).
- ※ For optimal high-quality footage, keep the camera lens and windshield clean.
- ※ Make sure the device does not interfere with the drivers' vision.
- ※ Adjust the camera lens to show approximately 40% of the car bonnet on the bottom of footage
- ※ **Before concealing the cables, make sure that the F/R connection cable, rear camera and hardwire power cable are all working properly.**
Make sure GPS signal is acquired and stable.
After testing the above, conceal the cables neatly along the headliner to finish the installation.
- ※ The manufacturer is not responsible for any damages due to not following above mentioned instructions.

4-2. Step-by-Step Installation Guide

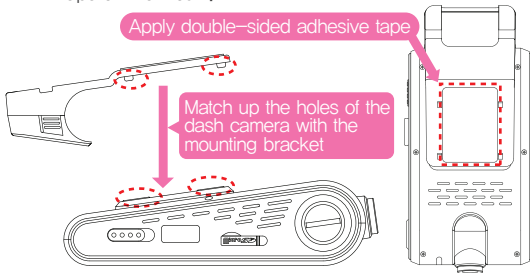
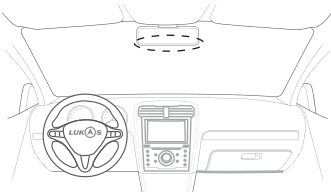
- 1 Align the mount to the mount rail on the device, and slide it until you hear a click. Apply the double-sided adhesive tape on the mount.

- 2 Select an installation location where the driver's vision is not obstructed. Remove the protective tape and press the mount to the installation location. Ensure the mount is firmly fixed. Do the same for the rear camera after selecting an installation location.

 - ※ Detaching and reattaching the adhesive tape causes the tape to lose its stickiness.

4-2. Step-by-Step Installation Guide

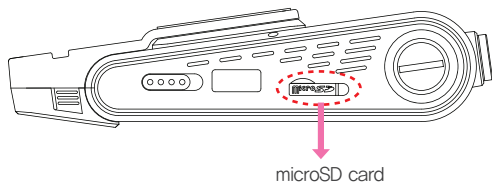
- 3** Check if you have Wi-Fi dongle and micro SD card correctly inserted into the device.

※ Without a microSD card inserted, the device cannot start recording properly.



- 5** Connect the front camera and the rear camera with the F/R connection cable.

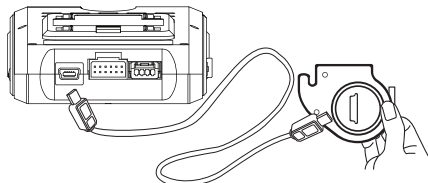

- ※ When connecting and disconnecting the rear camera from the cable, the dash camera will automatically turn off and restart.
- ※ If the cable is remained connected to the front camera while the other end of the cable to the rear camera remains unconnected, the camera stops recording and will continue to restart until it is correctly connected.

- 4** Connect the power cable to the device's DC-IN power port and conceal the cable along the driver side A-pillar.

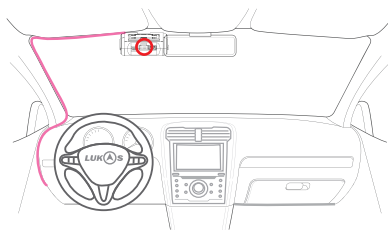

- 6** After installation is complete, please turn on the dash camera while the car ignition is ON. The power switch must be either at ACC or ON. Examine the LCD screen to check the operation of the dash camera.

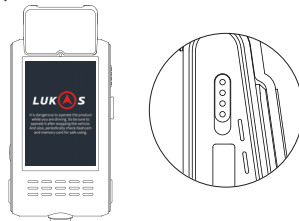

- ※ When connecting or disconnecting the F/R connection cable, make sure the dash camera is turned off to avoid any damage.

4-3. How to Hardwire Continuous Power Cable

1



Locate the fuse box and the chart that shows what each fuse is for. Choose where to hardwire the B+ and ACC wires.

※ Using a fuse removal tool can make the hardwiring process easier.



2

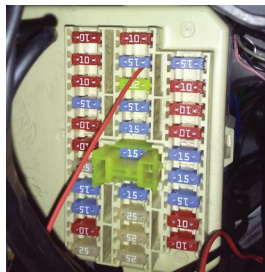

Identify a ACC fuse to connect with the red ACC wire and insert it back to the fuse box.

※ Location of ACC power source may differ by car manufacturers and models.
※ Please connect the ACC wire to the output terminal. If wired incorrectly; there is a risk of a fire.

3

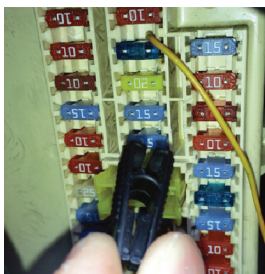

Identify a B+ fuse to connect with the yellow B+ wire and insert it back to the fuse box.

※ Location of B+ power source may differ by car manufacturers and models.
※ Please connect the B+ wire to the output terminal. If wired incorrectly; there is a risk of a fire.

4



Connect the black GND wire to a grounding source. (e.g. metal component)

※

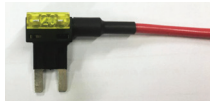

If the power cable is improperly hardwired, the dash camera will not function normally. We recommend using a dual fuse holder in the adjacent photo to make the process easier.

4-5. How to Adjust Camera Angle

- ▶ Users can easily adjust the camera angle by examining the real-time video on the LCD screen.
- ▶ Adjust the angle to display approximately 40% of the vehicle hood (bonnet) on the LCD screen as shown below. (Below the red line)
- ※ If the lens is facing downwards, it may not record traffic lights. And if the lens is facing upwards, footage may look dark overall.
- ※ Follow this camera angle instruction if you are not using ADAS. Go to page 37 for information on camera angle for ADAS

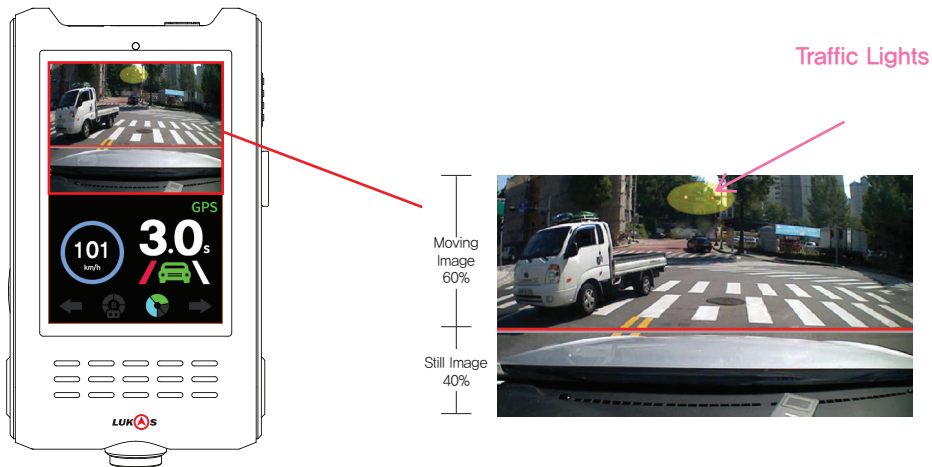

■ 4–5. Memory Card Recording Time ■

- One Continuous (Always) recording file is 3–minute long, and a Motion/Event recording file is 30–second long.
- Below table is based on the default memory card partition setting : Continuous 70%, Motion Detection 20%, Event Recording 10%
- Below table is based on video quality setting at Highest.

		8G	16G	32G	64G	128G	256G
Continuous Recording (3–minute file)	File Count (Front)	11	24	49	102	202	404
	File Count (Rear)	11	24	49	102	202	404
	Total Recording Time	1h 6min	2h 24min	4h 54min	10h 12min	20h 12min	1day 16h 24min
Motion Detection (30–second file)	File Count (Front)	20	41	85	174	347	694
	File Count (Rear)	20	41	85	174	347	694
	Total Recording Time	20min	41min	1h 25min	2h 54min	5h 47min	11h 34min
Time Lapse (30–second file)	File Count (Front)	20	41	85	174	347	694
	File Count (Rear)	20	41	85	174	347	694
	Total Recording Time	5h	10h 15min	21h 15min	43h 30min	3day 14h 45min	7day 5h 30min
Event Recording (30–second file)	File Count (Front)	10	20	42	87	173	346
	File Count (Rear)	10	20	42	87	173	346
	Total Recording Time	10min	20min	42min	1h 27min	2h 53min	5h 46min

- ※ The table above is an approximation only. Actual recording time and file counts can be slightly different.
- ※ Total recording time counts each front and rear video file as a set, (Front and rear video files are saved separately.)
- ※ In Parking Mode Recording, Motion Detection and Time Lapse Recording cannot be used at the same time (Choose either one option in settings.)

5. Device Operations

1. How to Start and Stop Recording

Manipulate the power switch on the dash camera.

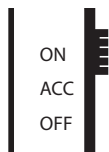

- ON : Supports recording during driving and the car is parked. (In Parking Mode Recording, the device records during the pre-set voltage or time before shutdown.)
 - ACC : Supports recording only during driving (Records while the engine is on and stops when the engine is off)
 - OFF : Power not supplied to the device.
- ※ Before turning on the dash camera, make sure a microSD card is inserted into the front camera.
 ※ Lukas logo will appear on the LCD screen when turning on the dash camera.
 ※ After the device is turned on it will start recording after the voice message "Drive safely. Recording started."

2. Recording Modes

	Continuous Recording	Motion Detection Recording	Event Recording	Emergency Recording
Folder	AlwaysMovie	MotionMovie	EventMovie	EventMovie
File Length	3 minutes	30 seconds	30 seconds	30 seconds
Video	Always	Parking	Event	Event
Characteristics	Records continuously while driving	<ul style="list-style-type: none"> - Records when the vehicle is parked either in Motion Detection or Time Lapse Recording - User settings available to set the level of motion detection sensitivity. 	<ul style="list-style-type: none"> - Records when impact is detected during driving or parking - User settings available to set the level of G-sensor sensitivity. 	Records when the emergency recording button is pressed.

※ When Time Lapse is selected for Parking Mode Recording, Event Recording cannot be selected.

3. Real-Time Video

Real-time video will be on the LCD screen after turning on the dash camera.

※ To display real-time video on the LCD screen : Main menu > Real-time.

※ Real-time video on Lukas App : Touch 'Lukas Connection' icon after connecting to the dash camera Wi-Fi.

4. Video Playback

On LCD screen : Home icon > Main menu > Play.

Lukas App : Touch 'LUKAS Connection' after connecting to the dash camera Wi-Fi.

PC Viewer : Connect SD/microSD Card to a PC. Download Lukas Viewer or use other media players.

5. Security LED

	During Continuous Recording	During Parking Mode Recording	Event/Motion Detected
Front	Blue LED light stays on continuously	Blue LED light blinks slowly	Red LED light blinks fast
Rear	Blue LED light stays on continuously	Blue LED light blinks slowly	Blue LED light blinks fast

※ Security LED can be turned on and off in settings. Default setting is on.

6. Operating Status LED

During Recording	ADAS not in operation (not calibrated)	ADAS function not working normally
Orange LED light stays on continuously	Orange LED light stays on continuously	Orange LED light blinks fast

7. Driving Mode Recording

– Continuous (Always) Recording : Continuously records and saves 3–minute videos in AlwaysMovie folder.

※ 'Always' stamp will be on the bottom of footage recorded in Always mode.

– Event Recording : Records and saves a 30–second video in EventMovie folder when an impact is detected (10 seconds before and 20 seconds after the impact.)

– Manual (Emergency) Recording : Records and saves a 30–second video in EventMovie folder upon pressing the 'E' button for approximately one second (10 seconds before and 20 seconds after the button is pressed.)

※ Manual Recording does not take place during Event Recording and vice versa.

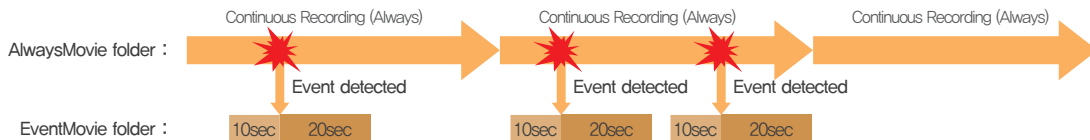

8. Recording in Parking Mode

- Parking Mode is activated only when the power switch is at ON.
 - ※ Note that the recording stops and the dash camera turns off when the vehicle's battery drops below a pre-set voltage level.
- How to Switch to Parking Mode : Set timer for 'Auto-Conversion to Parking Mode' option. With this option enabled, the dash camera will switch to Parking Mode after the pre-set time when the car ignition is turned off. When switched to Parking Mode, you will hear the voice message 'Switched to Parking Mode Recording.'
 - ※ Set timer for Parking Mode switch (Main Menu > Setting > Basic)
 - ※ When switching to and from Parking Mode and Driving Mode Recording, less than 5 seconds of video may be lost.
- Videos recorded in Parking Mode will have 'Parking' stamp on the bottom of footage.
 - ※ When switching to and from each recording mode, recording stops before the switch. For this reason, video loss may occur.
- When Motion Detection Recording is activated in user settings, a 30-second video is recorded when motion is detected. Files are saved in ParkingMovie folder. (10 seconds before and 20 seconds after motion is detected.)
 - ※ Settings for Motion Detection Recording can be changed. (Setting > Basic > Motion detection)
 - ※ Motion Detection Recording only records when motion is detected in Parking Mode. When motion is detected, Security LED will change to red and blink fast.
 - ※ Motion may not be detected when the surrounding of the vehicle is too dark.
 - ※ The total recording time of Parking Mode Recording may vary depending on the vehicle's battery status.
 - ※ Depending on where the vehicle is parked, motion may not be detected or there might be frame rate drops.
 - ※ Motion can constantly be detected due to the surrounding environment of the vehicle. The level of motion detection sensitivity must be set in accordance with the user's parking environment.
(e.g. If the vehicle is parked on a street or an underground parking lot, frequent movements may cause the camera to constantly record motion.)
- When Time Lapse Recording is activated in user settings, 30-second videos are recorded and saved in MotionMovie folder. Time Lapse Recording captures at one frame per second when the vehicle is parked.
 - ※ Each file is 30 seconds and spans about 7 minutes 30 seconds.
 - ※ Event/Motion Detection Recording does not operate if Time Lapse Recording is activated.

9. Driving Information

- Lukas dash cameras save up to 2 million driving information data onto the microSD card. After you set the time interval for saving the driving information in settings, the dash camera will automatically save the data on a regular basis.

10. Advanced Driver Assistance System (ADAS)

- Lane Departure Warning System (LDWS)
 - ※ When Auto-Calibration is complete after driving at a speed greater than 30km/h for about 3 minutes, the color of Lane Departure line on the LCD screen will change from yellow to white.
 - ※ Based on the real-time video, LDWS gives a warning when the driver changes a lane.
 - ※ LDWS functions according to LDWS sensitivity and speed settings set up by the user (Setting > ADAS)
(e.g. If speed setting is 50km/h, LDWS gives a warning only when the driver changes a lane at a speed greater than 50km/h)
 - ※ Depending on the LDWS settings, the warning sound and the color of Lane Departure line can be different.
- Front Collision Warning System (FCWS)
 - ※ Based on the real-time video, FCWS gives a warning on the screen with a symbol of car in red if a collision is imminent.
 - ※ FCWS functions according to FCWS sensitivity and speed settings set up by the user (Setting > ADAS)
(e.g. If speed setting is 30km/h, LDWS gives a warning only when the car is driving at a speed greater than 30km/h and is at a risk of a collision)
 - ※ Depending on the FCWS settings, the warning sound and the symbol can be different.
- Front Car Moving Detection (FCMD)
 - ※ Based on the real-time video, FCMD gives a warning on the screen with a symbol of car in blue when the car in front is starting to move forward.
 - ※ When the car remains stopped and the car in front is starting to move forward, FCMD will give a warning within 4 seconds.
 - ※ FCMD may give warnings if there is an object moving between the driver's car and the car in front.

11. Night Vision

- When using Night Vision in Parking Mode, the brightness will be enhanced for optimal video quality, especially in low-light conditions.
 - ※ Night Vision settings can be turned on and off. (Setting > Additional)

6. How to Use Lukas Dash Camera

6-1. Getting Started

※ To power the dash camera, start the car engine, followed by turning on the power switch of the dash camera on the right side of the front camera. Once the dash camera is turned on, Continuous Recording will automatically start with real-time video showing on the LCD screen of the front camera.

1. Date/time display and real-time video of the front camera.
Touch the top half of the screen to change between date/time display and real-time video of the front camera.
2. ADAS display and real-time video of the rear camera.
3. Home icon (Main Menu) : Click on the home icon to navigate to main menu including dash camera settings.
4. Wi-Fi : Turn on/off Wi-Fi
 - Grey : Wi-Fi OFF
 - Red : Wi-Fi ON and ready to connect to Lukas APP on a smart device
 - Green : Wi-Fi ON and connected to Lukas APP on a smart device
5. ADAS icon
 - Auto Calibration : ADAS icon appears when Auto Calibration complete (Auto Calibration requires GPS signal to be received and driving for 2-4 minutes at a speed higher than 30km/h)
 - Manual Calibration : ADAS icon appears when the dash camera turns on.
 - ADAS Setting : Touch the ADAS icon to move to Setting > ADAS Setting
 - Re-calibration : Touch the ADAS icon for more than 3 seconds to cancel the calibration.
6. Audio Recording : Displays Audio Recording On/Off Status
7. Voltage : Displays car battery voltage (voltage supplied to the dash camera)
 - ※ Voltage display indicates voltage supplied to the dash camera from the car battery.
This reading can be different from the actual voltage of the car battery due to possible voltage drops through the power cable.

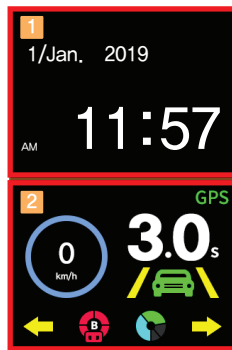

〈Main Display〉



〈Front/Rear Real Time Display〉

6-2. Parking Surveillance Notice

※ Parking Surveillance Notice provides information on the number of Motions and Events that are detected during Parking Mode Recording.

1. Indicates time when Parking Mode has started.
2. Number of Motion detected : each number indicates a set front and rear footage that are saved separately as two video files.
3. Number of Event detected : each number indicates a set front and rear footage that are saved separately as two video files.
4. Indicates time when Parking Mode has ended.
5. Indicates when Event has been detected during the period of time when the dash cam recorded in Parking Mode.



■ 6-3. Home(Main) Menu ■

※ Touch the Home icon on the real-time video screen to move to this menu.

1. Real-Time : Check real-time footage of the front and rear camera.
2. Video Playback : Check video clips recorded in various recording modes.
3. Configuration Setting : Change settings of the dash camera.
(settings for recording, LCD, audio and ADAS)
4. Card Format : Format microSD card and setting for scheduled memory card format.
5. ADAS Guide : Settings for manual calibration.
6. Version Check : Check device software versions.
※ Memory card needs to be formatted in order to apply new time setting.
7. Time Setting : Change date and time of the dash camera.
8. Current Date & Time

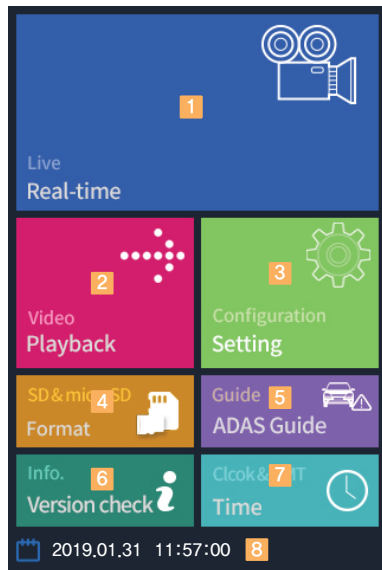

6-4. Real-Time Video

- ※ Live view of the dash camera will be shown on the screen.
 - ※ When calibration is not complete (ADAS icon not shown on the screen), ADAS functions will not work.
 - ※ It may take some time to complete ADAS calibration depending on the user's environments.
 1. GPS Status – White : No GPS (GPS Status stamp on footage : 'F')
 - Green : GPS signals received (GPS Status stamp on footage: 'A')
 - Red : GPS signals not received (GPS Status stamp on footage: 'V')
 2. Driving Speed
 3. TTC (Time To Collision) – Above 2.7 seconds : white, indicating low risk
 - Below 2.6 seconds: red, indicating high risk
 - CAL : Calibration incomplete
 4. Lane departure to the left – White: Left side lane marking detected
 - Yellow: Left side lane marking not detected
 - Red: Indicates lane departure to the left
 5. FCWS (Front Collision Warning System), FCMD (Front Car Moving Detection)
 - Green: Indicates detection of the car in front
 - Red: FCWS warning
 - Blue: FCMD warning
 - Yellow: Calibration incomplete
 6. Lane departure to the right – White: Right side lane marking detected
 - Yellow: Right side lane marking not detected
 - Red: Indicates lane departure to the right
 7. Left turn Signal
 8. Brake pedal on/off
 9. RPM Level
 10. Right turn signal
- ※ 7~10 information only available with extension cable (option)



6-5. Playback

※ Touch 'Video Playback' from the main menu to move to the list of saved video clips.

※ Video recording stops when the dash camera enters Video Playback menu. Stop the car in a safe place before using this menu.

※ Video recording starts automatically when you exit Video Playback menu.

※ File name is automatically generated in "Year/Month/Day/Time" format.

1. Video Play List : Displays the play list in sequential order.
2. Front/Rear Video Icon : Icons to distinguish front / rear videos.
3. Mode Selection Button :

Three sub-menus for Always / Event / Parking recordings.

▼▲ Sort video clips in ascending/descending order.

4. Video Playback : Recorded video will be played on the screen.

※ Touch each video file to play the video.

※ Video recording stops during playback.

5. File Name : File name of the video being played on the screen.

6. Progress Bar : Displays the total and progress time of the video being played.

7. Player Buttons : Play and pause the video being played and move to the previous and next video.

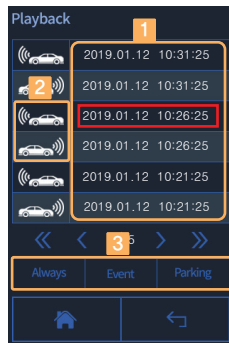

⟨Playback List⟩

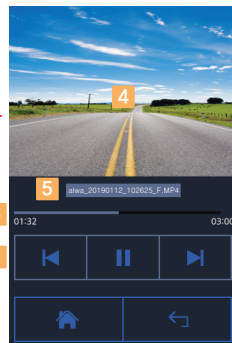

⟨Playback Footage⟩

6-6. Settings

※ To change settings, touch 'Configuration Setting' from the main menu.

1. Video : Change settings related to video recording
(Image Quality, Brightness, Mirror Image etc.)
2. Audio : Change settings related to audio recording
(Voice recording volume, speaker volume, hourly alarm and language)
3. LCD : Change settings related to the LCD screen
(Screen Stanby, brightness, night brightness, touch calibration.)
4. Basic : Change basic camera settings
(G-sensor, timer for Parking Mode switch, SD card storage allocation,
Parking Mode settings)
5. Additional : Change settings related to Continuous power supply(voltage & timer cut-off),
Security LED, Night Vision, and resetting to factory settings.
6. ADAS : Change settings for ADAS (Auto-Calibration, LDWS, FCWS, FCMD settings)

※ New settings will be applied when exiting the Setting Menu.

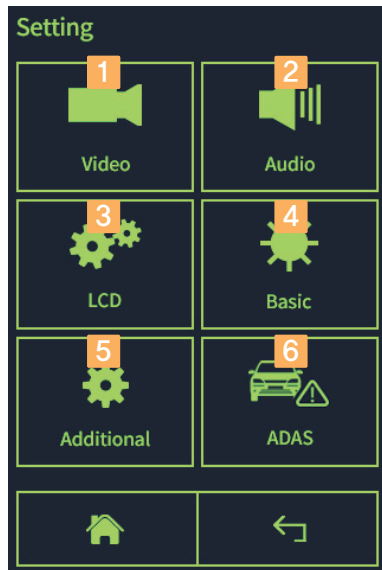

6-6-1. Settings – Video

※ To change video settings, touch 'Video' from the Setting menu.

※ Touch each icon to change individual settings.

1. Front Camera Video Quality : Change the video quality of the front camera.
2. Rear Camera Video Quality : Change the video quality of the rear camera.
※ Rear camera has to be connected to change this setting.
3. Front Camera Brightness : Change the image brightness of the front camera.
(from 1~5)
4. Rear Camera Brightness : Change the image brightness of the rear camera.
(from 1~5)
5. Reverse Rear L/R : Reverse rear camera image.
※ Rear camera must be connected to change this setting.
6. View Angle Setting : Change view angle setting for ADAS and DASHCAM.
 - ADAS: Zoom In angle to increase detecting distance of front vehicles.
 - DASHCAM: Wider angle to record more of the surrounding of the driver's vehicle.

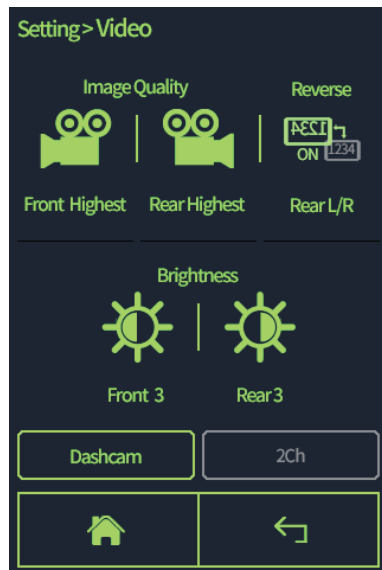

6-6-2. Setting – Audio

※ To change audio settings, touch 'Audio' from the Setting menu.

1. Voice Recording : Change the volume of voice recording or turn of voice recording.
2. Speaker : Change the speaker volume.
3. Hourly Alarm : Turn ON/OFF hourly alarm.
4. Voice Guidance : Change the language of Voice Guidance.
 - GUI : Korean, English, Japanese, Chinese
 - Voice Guidance in 21 languages : English, Korean, French, Latin American Spanish, European Spanish, Arabic, Chinese, Russian, Japanese, Thai, Bahasa Indonesia, Mongolian, Vietnamese, Malay, German, Turkish, Italian, Hindi, Cantonese, Czech, Portuguese

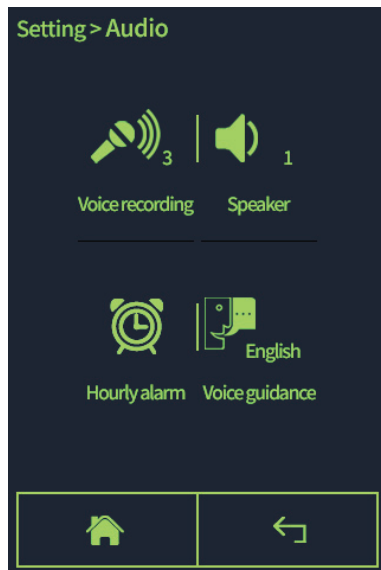

6-6-3. Setting – LCD

※ To change LCD settings, touch 'LCD' from the Setting menu.

1. Screen Standby : Timer for turning off the LCD Screen. (15, 30, 60 seconds, On)
 - ※ 'On' setting : LCD screen does not turn off during driving.
 - ※ In Parking Mode, LCD screen turns off regardless of this setting.
 - ※ After a preset time, the LCD turns off and turns back on when you touch the LCD screen.
2. Brightness : Change LCD brightness (from 1-3)
 - ※ Auto : Automatically adjusts LCD brightness according to changing light conditions.
3. Auto Brightness : Turn on/off Auto Brightness. The LCD brightness will automatically be lowered between 8pm ~ 6am the next day.
4. Touch Calibration : Calibrate the touchscreen when touches are detected inaccurately.
 - ※ Press the E button for more than 2 seconds to go to calibration screen.

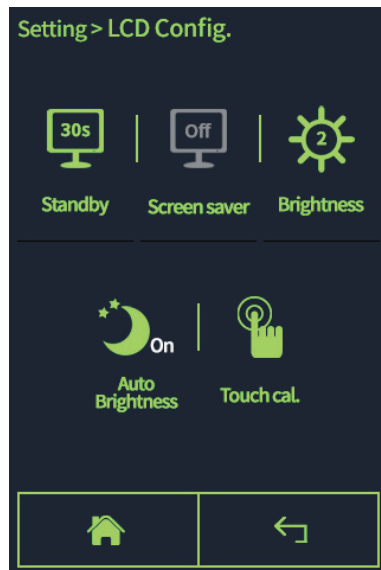

6-6-4. Setting – Basic

※ To change basic settings, touch 'Basic' from the Setting menu.

1. G-sensor : Change the level of G-sensor (Impact) sensitivity (from 1~5).
Separate G-sensor sensitivity settings for Driving and Parking Mode.
2. Auto-parking : Set timer for switching to Parking Mode Recording after turning off the car ignition (Off, 10 sec, 30 sec, 1 min, 2 min, 3 min, 5 min, 7 min, 10 min.).
3. SD allocation : Allocates storage capacity for Continuous, Motion Detection/Time Lapse, and Event files on the SD card.
4. Parking Mode : Change settings for Parking Mode Recording (Time Lapse, Motion Detection, and Motion Detection Sensitivity).
 - ※ Motion sensitivity and motion area can be set for front and rear camera.
 - ※ Motion & Impact Detection and Time Lapse Mode cannot be selected together.

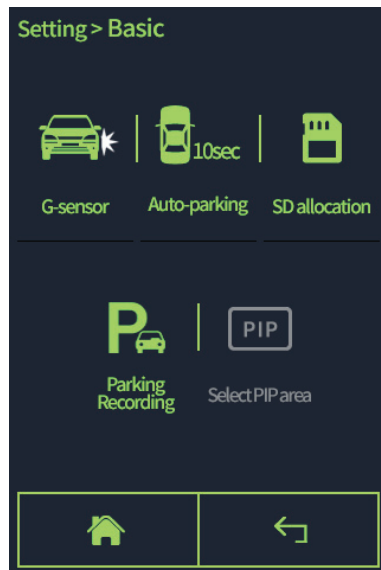

6-6-5. Setting – Additional

※ To change additional settings, touch 'Additional' from the Setting menu.

1. Continuous Power Supply : Change cut-off voltage or timer to prevent battery discharge during Parking Mode Recording.
 - ※ When using an external battery pack to power the dash camera, please select 'On' for External Power Supplies setting.
 - ※ When using an external battery pack the cut-off voltage or timer is deactivated.
2. Security LED : Turn On/Off front and rear Security LED.
3. Night Vision : Turn On/Off Night Vision.
4. Initialize : Go back to factory settings.

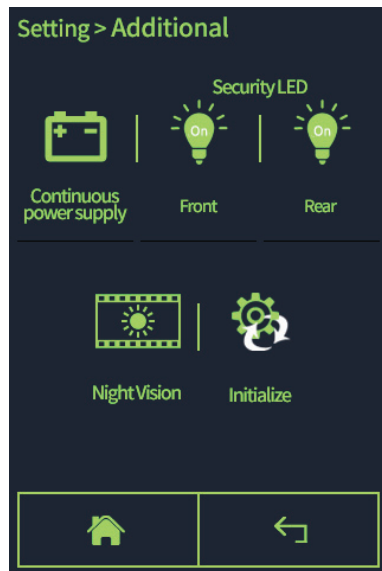

6-6-6-1. Setting – ADAS Setting

※ To change ADAS settings, touch 'Additional' from the Setting menu.

1. Auto-Calibration : Turn on/off auto-calibration
 - Auto-Calibration ON : After GPS signal is received, it calibrates automatically to align the camera with horizon, vehicle's hood and center lines.
 - Auto-Calibration OFF : Users can manually calibrate the camera with horizon, vehicle's hood and center lines.
2. LDWS : Change LDWS settings.
 - Sensitivity : Change LDWS sensitivity setting based on the distance between the vehicle (tire) and the lane. (Sensitivity setting from 1 ~ 21 with higher number meaning higher sensitivity / recommended default setting: 11)
 - Speed : Change LDWS speed setting or turn off LDWS - the minimum speed at which LDWS activates the warning. (Speed setting from 10km/h~ 100km/h by 10km/h / recommended default setting: 40km/h)
3. FCWS : Change FCWS settings.
 - Sensitivity : Change TTC value at which FCWS activates the warning between 2.0s and 4.0s.
 - Speed : Change FCWS speed setting or turn off FCWS - the minimum speed at which FCWS activates the warning. (Speed setting from 10km/h~ 100km/h by 10km/h / recommended default setting: 10km/h)
4. FCMD : Change FCMD sensitivity from 1 ~ 3 or turn off FCMD. The warning when the vehicle in front starts moving ahead when your vehicle is at stop.



6-6-6-2. Setting – ADAS Setting – ADAS Advanced Settings

※ Go to Setting > ADAS Setting > ADAS Advanced Settings

1. UFCW Setting : Set FCWS sensitivity setting for vehicle speed below 30km/h.
Sensitivity setting range from 1 ~ 5, with higher number meaning higher sensitivity. (Recommended setting: sensitivity 5)
2. Vibrator Setting : Set Vibrator setting
(Not use, All, High level, High Speed / Recommended setting: All)
 - ※ Vibrator Operating Scenario for each setting.
 - Not use: Vibrator off
 - All : Vibrator operates at all circumstances of lane departure and front collision.
 - High level: Vibrator operates at all circumstances of lane departure and front collision except the very first alarm.
 - High Speed: Vibrator operates at circumstances of lane departure and front collision when the vehicle speed exceeds 60km/h.
3. Front Collision Distance : Set following distance for front collision warning.
Set from 1.1 ~ 1.5 by 0.05 increase.
(Recommended Setting: Sedan/SUV: 1.5, Bus/Truck: 1.25)
4. Front Collision Sensitivity : Set front collision sensitivity from 0,6 ~ 3,0 by 0,1 increase.
(Recommended Setting: Sedan/SUV: 1.0, Bus/Truck: 1.5)

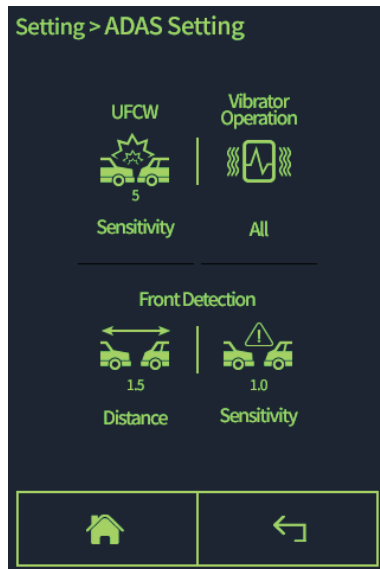

6-6-6-3. Setting – ASDAS Setting – Vehicle Advanced Settings

- ※ Go to Setting > ADAS Setting > Vehicle Advanced Settings to change settings for Dashcam Height, Lane Width and Vehicle Width.
- ※ To increase ADAS accuracy, please set ADAS Advanced Settings correctly.

1. Dashcam Height

- Set dashcam height from the ground level to the dashcam installed.
- Change by 1cm from 100cm to 299cm

2. Lane Width

- Set the lane width in according to road conditions
- Change by 0.1 meter from 3.0m to 4.0m
(For example, the average lane width of roads in South Korea is 3.4 meters)

3. Vehicle Width

- Set the vehicle width from where the tire begins on one end to the other end of the tire.
- Change by 1cm from 60cm to 300cm.

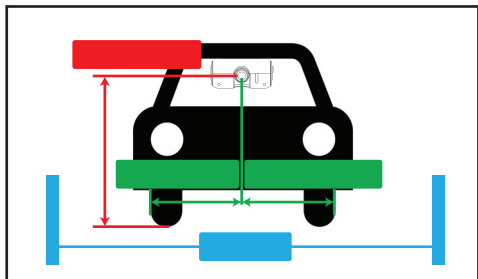

<Advanced Settings>



6-7. Memory Card Format

- ※ To change memory card settings, touch 'Format' from the main menu.
- ※ Please format the microSD card on a regular basis (Once a month for 8GB Memory card)
- ※ Make sure to back up important video files before memory card format.

1. microSD Card : Format the microSD card.
2. Automatic Formatting : Set up a reminder for memory card format.
(Every 4 weeks / 8 weeks / 16 weeks / 32 weeks /
turn off the reminder)

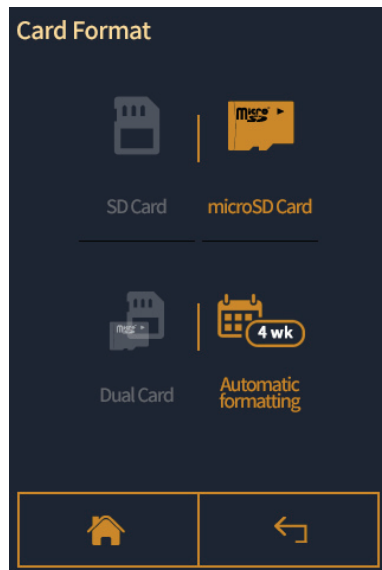

6-8. ADAS Guide

※ Go to Home > ADAS Guide for manual calibration.

1. Manual Calibration Setting

- ① G-Sensor
: Change the angle of front camera lens to change G-sensor value.
: The value should be between -0,3 and 0,3
- ② Horizon (Red line) setting
: Align the red line with the horizon of the real-time view of the front camera.
: + and - buttons will move the red line up and down
- ③ Bonnet (Green line) Setting
: Align the green line with the far end of the car bonnet.
: + and - buttons will move the green line up and down
- ④ Center (Vertical blue line) setting
: Align this line with the location of the front camera
: + and - buttons will move the blue line to the left and right

2. How to manually calibrate ADAS

- ① Touch the ADAS icon from the real-time view on the front camera for about 3 seconds.
- ② From the ADAS Guide menu, touch the + and - icons to manually align the camera with the three lines in red, green and blue.
- ③ Go to Home > Setting > ADAS Setting and turn off Auto-Calibration.
- ④ ADAS icon will be on the screen and the manual calibration settings will be applied.



6-9. Time Setting

※ To change time and date settings, touch 'Time' from the main menu.

※ Memory card needs to be formatted after changing time settings.

1. Time Setting : Manually change time and date.
2. GMT Setting : Change GMT & DST setting
(Automatically sets local time – GPS-installed device only)

Time setting

2019 Y
1 M 11 D

AM
11 H 57 M

GMT GMT +09:00
 Daylight saving time

+ - Save

Home Back

7. Lukas Application

7-1. Getting Started with Lukas App

- ※ Download the Lukas application on your smartphone. The Lukas App can be found on the Google Play Store and the App Store.
 - The Lukas App can be used with Android 6.0 or higher, iOS 8.0 or higher.
 - The Lukas App may not be supported depending on the types of smartphones.
- ※ Please check if the Wi-Fi icon on the top right-hand corner has changed to green color which indicates successful connection with your smartphone.
- ※ Wi-Fi reception and data transfer rates may vary and affect playback of recorded videos.
- ※ The range of Wi-Fi may vary.
- ※ The storage path of downloaded videos may vary depending on the user's smartphone.



[Download the Lukas App on Google Play]



[Download the Lukas APP on Apple App Store]

7-2. Connecting to Lukas App

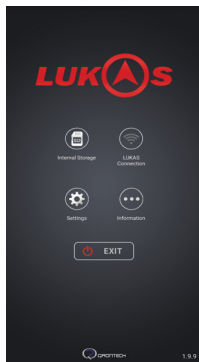

[Lukas App Main Screen]

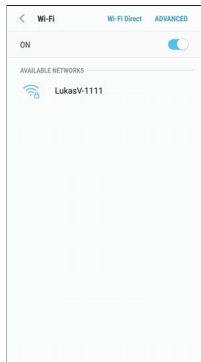

[Connect Smartphone via Wi-Fi]

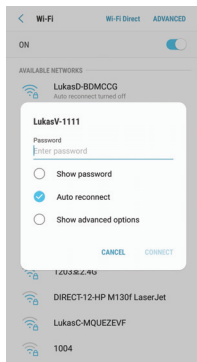

[Enter Password]

1. Click on LUKAS Connection to enter into Wi-Fi Connection mode.
 - ※ When the device is connected to a smartphone, the icon will turn green.
2. Select the Wi-Fi network starting with 'LukasV' from the list.
3. Enter default password '11111111'.
4. Press Exit to close the APP and restart recording.
 - ※ For a stable connection, please remain within close proximity to your dash cam.
 - ※ Change your password to prevent others from accessing your dash cam data.
 - ※ Device name and password can also be changed on Lukas Viewer.

7-3-1. How to Use Lukas App – Internal Storage

※ Click on 'Internal Storage' icon to watch downloaded videos on your smartphone.



- 1, Back : Go back to the main screen.
- 2, Always Video : Only shows Always(Continuous) videos on the list.
- 3, Event Video : Only shows Event videos on the list.
- 4, Motion Detection Video : Only shows motion detection videos on the list.
- 5, Ascending/Descending : Arrange the order of video files by time sequence.
- 6, Play : Play selected video.
- 7, Delete icon : Delete selected file.
- 8, Recorded date and time
- 9, File name
- 10, File size
- 11, Lukas : Go to 'LUKAS Connection' for live viewing and playback.

7-3-2. How to Use Lukas App – LUKAS Connection

- ※ When your smartphone is connected to the dash camera 'LUKAS Connection' icon will turn green. When disconnected, the icon will be gray.
- ※ When entering LUKAS Connection menu for live view, playback and download, recording stops and resumes when connection is expired.

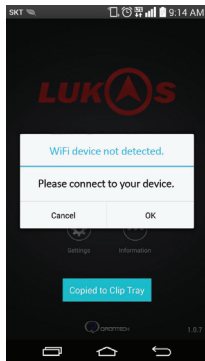

[When Wi-Fi is not connected]

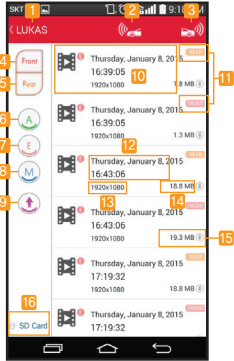

[Wi-Fi Connected]

1. Back : Go back to the main screen.
2. Front Live Stream Button : Watch Real-time video of front camera.
3. Rear Live Stream Button : Watch Real-time video of rear camera.
4. Front Video : Only shows front videos on the list.
5. Rear Video : Only shows rear videos on the list.
6. Always Video : Only shows Always(Continuous) videos on the list.
7. Event Video : Only shows Event videos on the list.
8. Motion Detection Video : Only shows motion detection videos on the list.
9. Ascending/Descending : Arrange the order or video files by time sequence.
10. Play : Play selected video.
11. Front/Rear Video : Indicates video files from front or rear camera.
12. Recorded date and time
13. Video Resolution
14. File Size
15. Download Button : Download the selected video to internal storage of the smartphone
※ Storage path of downloaded videos may be different by smartphone models.
16. SD Card Button : Move to 'SD Card' page.

7-3-3. How to Use Lukas App – Settings

- ※ Settings only available when the device is connected to a smartphone.
- ※ Some of the menu items may be different depending on the model of the smartphone.
- ※ Keep the dash cam turned on while saving the changed settings.

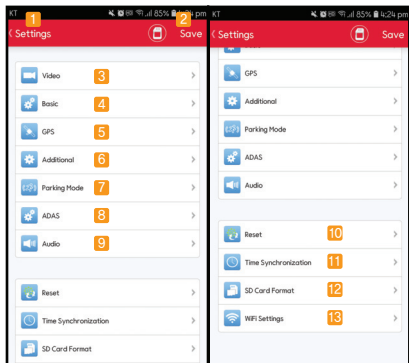

- 1, Back : Go back to the Main Screen.
- 2, Save : Changes will be saved and applied.
- 3, Video : Configure video settings.
- 4, Basic : Configure basic settings & functions.
- 5, GPS : Configure GPS settings.
- 6, Additional : Additional settings and functions.
- 7, Parking Mode : Set Motion Detection sensitivity for the front and rear cam.
- 8, ADAS : Change ADAS settings. (LDWS, FCWS sensitivity and speed)
- 9, Audio : Configure microphone, speaker and language settings.
- 10, Reset : Reset your device to factory settings.
- 11, Time Synchronization : Synchronize time on the device with your smartphone.
- 12, SD Card Format : Format microSD card.
- 13, WiFi Settings : Change WiFi SSID and password.

7-3-4. How to Use Lukas App – Information

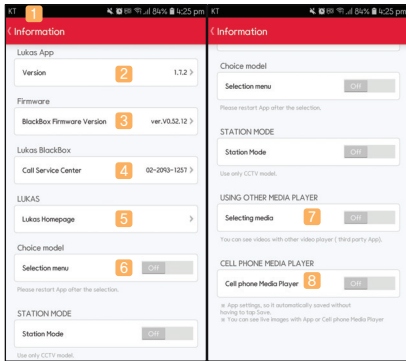

1. Back : Go back to the main screen
2. Version : Application version
3. Firmware : Firmware version
4. Call Service Center : Call Customer Support (Korea HQ)
5. Lukas Homepage : Visit Lukas website for more information
6. Choice Model : Choose between Lukas and Qvia logo for the main page of the application
7. Selecting Media : Use a third-party media player on your smartphone for live view and playback.
8. Cell phone Media Player : Use default media player on your smart phone for live view and playback.

8. Lukas Viewer

1. How to Install Lukas Viewer



※ Download Lukas Viewer from Lukas Website (www.lukashd.com)

Recommended PC Specifications for Lukas Viewer

OS : Windows XP SP3, Vista(32Bit), WIN7,8,10(32/64bit)

H/W : Quad core 2.8Ghz / 4G RAM or higher

Web browser : Microsoft Internet explorer 7.0 or higher

Direct X version : Direct X9.0 (JUNE 2010) or higher

Others : Windows.NET Framework 4 or higher

※ Dash camera models in this User Manual have video resolutions of QHD, FHD. Hence there might be occasional video and sound cuts, changes in play speed and other minor errors depending on a PC's specifications.

2. Lukas Viewer Overview

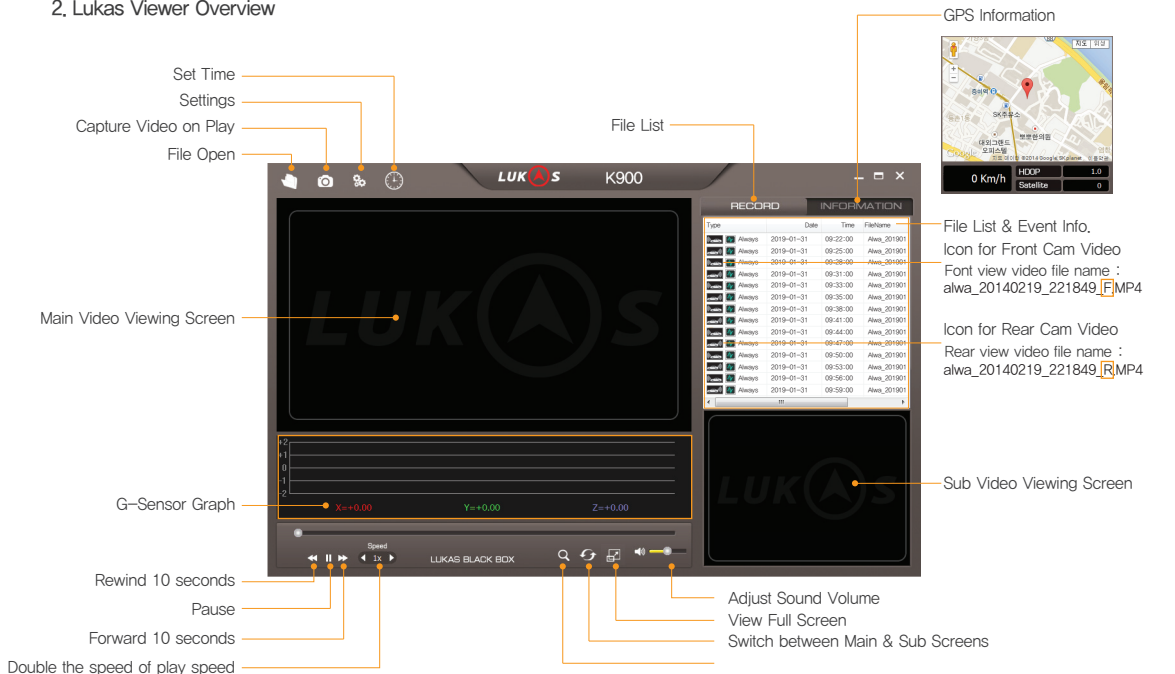

※ GPS map information may not be displayed if a PC is not connected to the Internet or GPS reception was unstable at the time of recording.

※ Map synchronization is supported only with Internet Explorer 7.0 or higher.

※ To watch the video in QHD, FHD resolution, play the video in full screen.

3. Dash Camera Settings on Lukas Viewer

- Change dash camera settings for each recording mode as desired on Lukas Viewer.

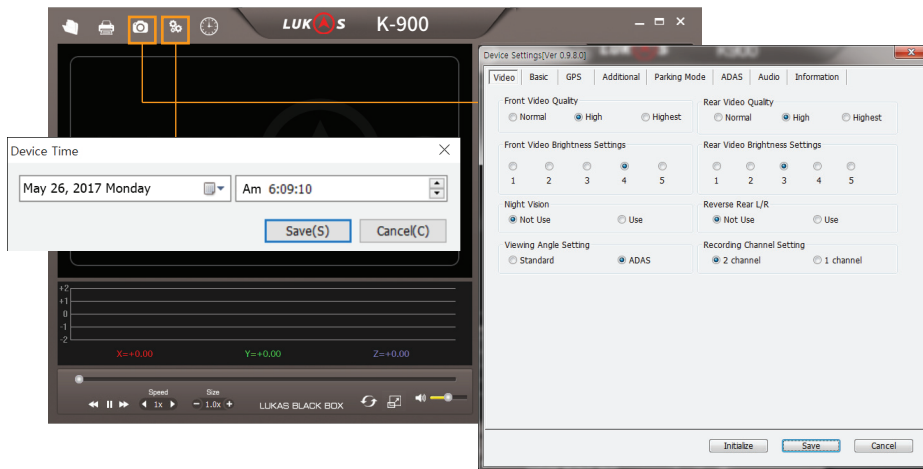

4. Video Playback Screen



1 2 3 4 5 6 7 8 9 10 11 12 13 14 15

※ GPS Reception

- A : Stable GPS Signal
- V : No GPS Signal
- F : No GPS Connected

※ Recording Mode

- Always : Always recording
- Parking : Parking Mode recording
- Event : Event recording
- Motion F/R : Motion Detection recording
(F : Motion triggered by the front camera / R : Motion triggered by the rear camera)
- OvTemp : Device entering High Temperature Mode
- Wi-Fi : Wi-Fi connected

※ OBD information

- X : No information
- BR : Brake
- LL : Left turn signal
- RL : Right turn signal

※ ADAS Information

- X : No information
- FC : Front Collision warning
- uF : Low speed Front Collision warning
- >> : Lane Departure to the right
- << : Lane Departure to the left

- 1 Date and time
- 2 Driving Speed
- 3 GPS Status
- 4 Mileage
- 5 Voltage Level supplied to the Dash Camera
- 6 Recording Mode
- 7 Vehicle Plate Number (Enter up to 8 digits)
- 8 Audio Recording On/Off
- 9 RPM
- 10 Dash Cam Temperature
- 11 TTC/DTC
- 12 GPS location
- 13 OBD, ADAS information
※ OBD information followed by ADAS information.
- 14 Dash Camera Model Name
- 15 Front and Rear video quality and brightness settings
 ※ In the order of the following : front video quality, front video brightness, rear video quality, rear video brightness.
 ※ Image brightness : 1~5
 ※ Image quality : N - Normal
 H - High
 S - Highest
 V - Using Night Vision

9. Specifications

Item	Specifications	Remark
Camera	Front Camera : 5.48M Effective Pixels Sony IMX326 Sensor, 1/2.9"(inch) Rear Camera : 2.13M Effective Pixels Sony IMX322 Full HD Sensor, 1/2.9"(inch)	
Viewing Angle	Front : Diagonal (approx. 120°) / Effective Viewing Angle : Horizontal (approx. 103°), Vertical (approx. 53°) Rear : Diagonal (approx. 125°) / Effective Viewing Angle : Horizontal (approx. 105°), Vertical (approx. 54°)	
Resolution & Frame	Front : 2560X1440p (QHD), 30fps / Rear : 1920X1080p (Digital Full HD), 30fps	
LCD Resolution & Size	Resolution(320*480) / Size : 3.5"(inch), Full Touch Screen	
Video Compression	MP4(MPEG)	
Gravity Sensor	Built-in 3-axis impact sensor (Impact, sudden brake, sudden start)	
GPS	Dual Band(GPS+Glonass)	
Storage Media	Memory card (Standard 32GB, Up to 512GB)	
Player Program	Lukas Viewer / General Media Player	
Audio	Built-in speaker, Microphone	
Power & Current Consumption	Power : DC 10V~24V, Power Consumption : 350mA (13.4V), approx. 4.7W	
Low-Voltage Cut-Off	Set Time & Voltage for Power Cut-Off, Supports Multi-Booting System	
Operating & Storage Temperature	Operating Temperature : -30°C ~ 80°C (-22°F ~ 176°F) Storage Temperature : -40°C ~ 90°C (-40°F ~ 194°F)	Including GPS, LCD Brightness at 1 and Wi-Fi turned off.
Size/Weight	Front : 76 X 133 X 36 (mm) , 170g / Rear : 50 X 26 X 31 (mm), 25g	



Quality Assurance

Model Name		Product S/N	
Customer Name		Date of Purchase	MM / DD / YY
Customer Phone No.		Place of Purchase	

1. A one-year warranty for the device is provided from the date of purchase.
2. For accessories including memory cards, the warranty period is six month.
3. This product has undergone strict quality control and inspection procedures.
4. This note is a proof of purchase and warranty. Thus, it cannot be re-issued. Keep this note for a warranty request.
5. Out-of-Warranty fees may be charged depending on the type of service.
6. If the product malfunctions under normal use conditions, there will be no repair costs during the one-year warranty.
7. Be sure to keep this note for a warranty request.

■ Certified Company Info. ■



1. Certified Company : Qrontech Co., Ltd.
2. Product Name (Model Name) : Lukas 2CH Dash Camera
3. Certificate No. : R-R-QRN-K900
4. Manufacturer / Country of Origin : Qrontech Co., Ltd. / S.Korea
Seller and user must note that this product has electromagnetic wave compatibility certificate, and is designed for use outside home.



Conformity European Marking
ES Joint Specification Certificate



U.S Federal Communications
Commission / Electromagnetic
Wave Compatibility Certificate

