

Step 4 Install the Device.

- 1) Put the hook on the mounting plate into the groove of the device.

Figure 3-3 Installation (2)

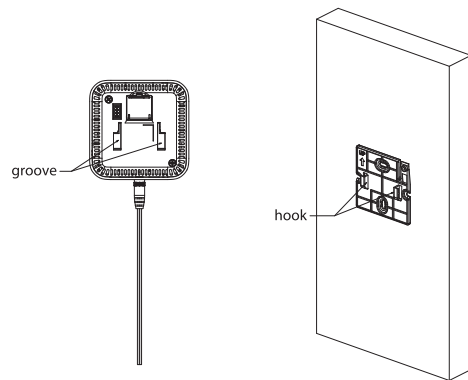

- 2) Put the device into the plate from top to bottom.

Figure 3-4 Installation (3)

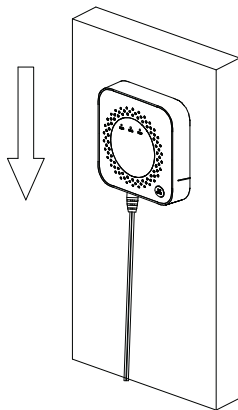

4 Test

After the installation of the Device or regular maintenance, a test must be carried out to confirm that the Device is operating properly.

During the testing process, the defective Device should be addressed according to "FAQ" and "Maintenance", and then tested again. If it fails to complete the test successfully, please send the Device to the manufacturer for repair.

Power on

After powering on, all indicator lights turn on for 3 seconds, the Device enters in warm-up status, and the Power indicator flashes. After 3 minutes, all indicators are constantly on 3 seconds and buzzer beeps.

Device self-test

- Short press the Test button, all indicator lights flash and buzzer beeps.
- Long press the Test button, all indicator lights flash and buzzer beeps. The valve starts to output after 5 seconds. Release the Test button, the alarm sound ends, the indicator lights return to normal working status, and the check is completed.

Alarm test

The alarm concentration value is set to 10% LEL. When the methane concentration reaches this threshold, the Alarm light flashes and the Device sends sound signal. When the concentration is lower than the predetermined value, the Device returns to its normal working state.

5 Operation

When the indoor methane concentration reaches the predetermined threshold, the Device sends out alarm signal. Please carefully review the following guidance to take proper action in the event of an alarm.

- Keep calm and ventilate the property by opening doors and windows.
- Stop using all fuel-burning appliances, and do not turn on or off lights until the room has been checked by an expert.
- Evacuate the property leaving the doors and windows open.
- Stay away from the leakage place. Call the Fire Department as soon as possible from outside.
- Don't re-enter the property until the alarm has stopped and the leakage source is handled.

6 FAQ

Problem	Analysis	Solutions
Green Power indicator light does not flash	Poor connection of power cable Indicator light is broken	Check the connection of power cable Contact with the manufacturer
Press Test button, there is no alarm	Circuit fault	Contact with the manufacturer
No response to detected methane	Circuit fault	Contact with the manufacturer
	Warm-up is not completed	Keep preheating sensor
Alarm sounds continuously	There is a large amount of volatile substances such as alcohol, perfume, gasoline, banana water and paint	Move it to clean air to test performance
	Store for too long	Keep powering on for 2 hours
	Circuit fault	Contact with the manufacturer

7 Maintenance

To keep your device in good working condition, please follow these requirements.

- Simulate fire alarm test: once half a year (recommended).
Under normal working conditions, press the **Test** button to ensure that the Device can work normally. If there is a malfunction, please repair it in time. After cleaning, please install the Device and test again.
- Clean the shell: at least once per year (recommended).
Keep the Device free of dust or inserts by gently vacuuming the shell with a soft brush attachment when required. Avoid cleaning solutions on the Device to prevent the possibility of contaminating the sensor.

For User's Manual in other languages, please scan the QR code below or visit <https://www.wisualarm.com/en/Products/ALL> to select specific product and see the manual.



Zhejiang HuaXiao Technology Co.,Ltd.

Address: Area A, Floor 3, Building C, No.28 Dongqiao Road, Dongzhou Sub-district, Fuyang District, Hangzhou City, Zhejiang Province, China
Website: <http://www.wisualarm.com/en/home>

Gas Alarm

User's Manual

V 1.0.0

1 Introduction

1.1 Overview

DHI-HY-GA40A Gas Alarm (Methane) (hereinafter referred to as the Device) is designed to continuously monitor methane concentration. Adopting a catalytic-type gas sensor, advanced electrical technology, MCU, a built-in high-volume buzzer, it responds quickly and becomes highly sensitive with stable performance and low false alarm. Once the surrounding methane concentration reaches the alarm value, it will promptly send out visual and audible alarm signal to remind the user to take immediate measures. Application scenarios include homes, restaurants, hotels and other places that require methane detection.

1.2 Structure

Panel

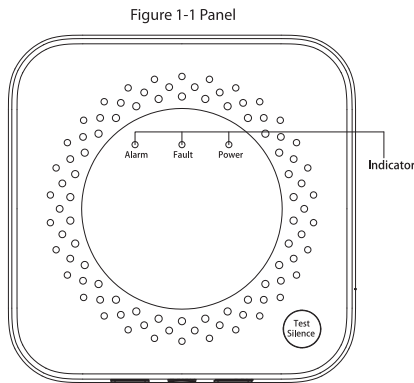

Figure 1-1 Panel

Status	Introduction
Power on	All indicators are constantly on for 3 seconds.
Warm-up	<ul style="list-style-type: none"> During warm-up period: Power indicator flashes 3 minutes. After warm-up period: After 3 minutes, all indicators are constantly on for 3 seconds, and buzzer beeps.
Standby	Power light is constantly on.
Fault	<ul style="list-style-type: none"> Malfunctioned sensor: Fault indicator is constantly on, the buzzer beeps continuously. End of life: Once the maximum lifetime (5 years) of sensor is reached, the Fault indicator flashes and the buzzer beeps.
Alarm	The alarm threshold is set to 10%LEL. When methane concentration reaches this threshold, the Alarm indicator is constantly on with the alarm sound.

1

Connection

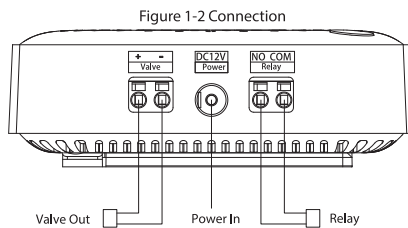

Figure 1-2 Connection

1.3 Dimensions

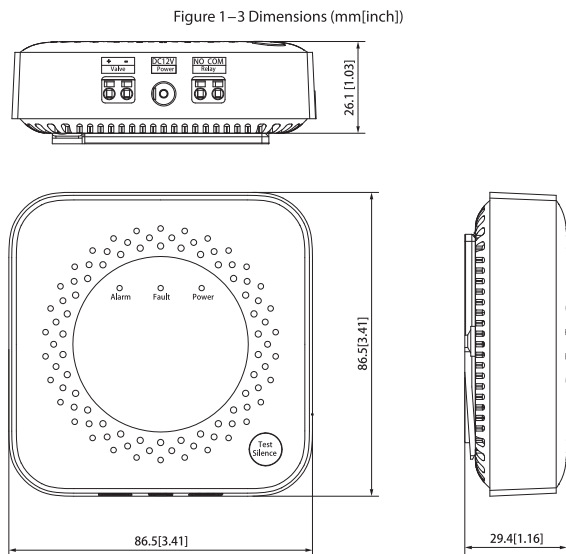

Figure 1-3 Dimensions (mm[inch])

2

2 Technical Information

Specification	Introduction
Model	DHI-HY-GA40A
Detection Gas	Methane (CH ₄)
Alarm Threshold	10% LEL
Response Time	≤30 s
Supply Voltage	DC12V
Power Consumption	≤0.8W
Output	1 valve output, 1 relay output
Operating Temperature	-10°C to +55°C (+14°F to +131°F)
Relative Humidity	≤95% RH (non condensing)
Warm-up Period	180 s
Alarm Method	Visual and audible alarm
Alarm Sound Level	70dB (A) at 1m (3.28 feet)
Silence	Support
Dimensions	86.6 mm × 86.6 mm × 29.2 mm (3.41" × 3.41" × 1.15")
Installation	Wall mount

3 Device Installation

3.1 Packing List

Check the package according to the following checklist. If you find device damage or any loss, contact the after-sales service.

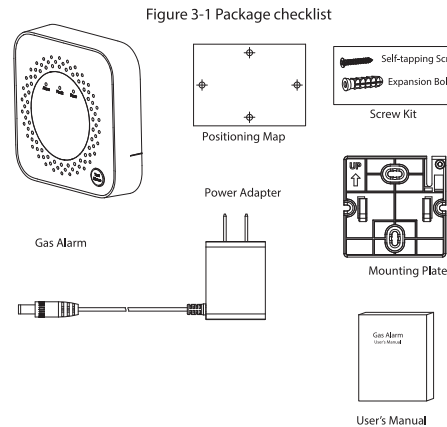

Figure 3-1 Package checklist

3

Table 3-1 Checklist

Name	Quantity
Gas Alarm	1
Positioning Map	1
Self-tapping Screw	2
Expansion Bolt	2
Power Adapter	1
Mounting Plate	1
User's Manual	1

3.2 Installation Position

This Alarm is intended for use in ordinary indoor locations of family living units.

- A well-ventilated place within 1.5 meters (4.92 ft) of cooking appliance is recommended.
- On the upper part of the methane source, and the horizontal distance from the burning appliance or valve should not be greater than 6 meters (19.69 ft), and it should not be installed above the burning appliance.
- Avoid the installation in the corners, cabinets and other places where the air is not easy to circulate, or in the places where it is easy to be directly smoked by oil fume.

3.3 Installation Steps

Follow below steps to install the device properly.

- Choose suitable place to install positioning map.
- Drill holes (Φ5 mm [0.20"]) on the wall as the positioning map shows, and then align the screw holes on the wall with the expansion bolts.
- Fix the mounting plate with self-tapping screws.

Figure 3-2 Installation (1)

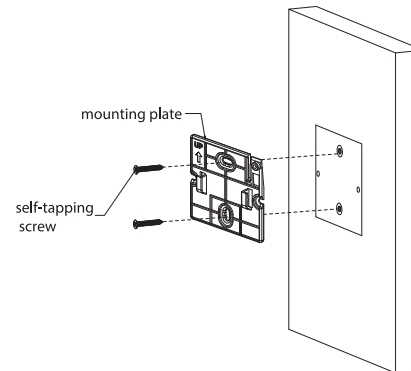

4