

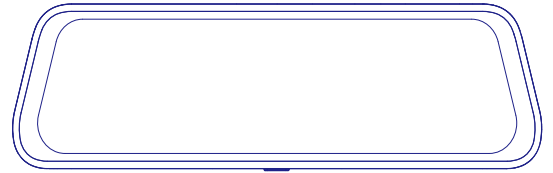

# Owner's Manual

AR09



KAKA GROUP LTD  
www.azdome.hk info2@azdome.hk  
Address : Room 102, Building 1, No.1 Longcheng Street, Qingxi Town,  
Dongguan, Guangdong, 523660, CN



V2.0

**AZDOME**

Enjoy Your Smart Driving



## CONTENT

WARRANTY & CUSTOMER SUPPORT .....	02	Button Sound .....	18
NOTICE .....	03	Speed Unit .....	18
SPECIFICATION .....	04	Frequency .....	19
PACKING LIST .....	05	Format Remind .....	19
PRODUCT DIAGRAM .....	06	Parking Guide Line .....	19
INSTALLATION .....	08	Rear Video Mirror .....	19
Install Micro SD Card .....	08	Time Lapse Parking Mode .....	20
Remove Micro SD Card .....	08	Parking Monitor .....	20
Front Camera Installation .....	08	Video Settings .....	22
Rear Camera Installation .....	10	Video Resolution .....	22
GET STARTED .....	13	Loop Recording .....	22
Power On/Off .....	13	WDR .....	22
Screen On/Off .....	13	Time-lapse Record .....	22
FORMATTING MEMORY CARD .....	13	System .....	23
SETTING TIMEZONE AND DATE/TIME .....	14	Language .....	23
BUTTON FUNCTION .....	15	GPS Info .....	23
FUNCTION .....	17	WiFi .....	23
General .....	17	Format .....	23
Parking Monitor .....	17	Reset Settings .....	24
G-sensor .....	17	Version .....	24
Video Stamp .....	18	PLAYBACK RECORDED VIDEOS .....	24
Screen Saver .....	18	GPS PLAYER SOFTWARE INSTALLATION (PC/MAC ONLY) .....	27
Timezone .....	18	FAQ .....	28
Time/Date Setting .....	18	DISCLAIMER .....	29
		WARNINGS .....	30

---

## •» WARRANTY & CUSTOMER SUPPORT

---

We provide 12-Month of limited warranty for your product from the date of purchase to be free from defects in materials and craftsmanship.

For questions, support, or warranty claims, contact us at **info2@azdome.hk** with you Order Number. If you can provide the photos or video to show your problem we will be appreciated.

IMPORTANT: Proof of original purchase (Online order receipt is also accepted) is required for any warranty service. AZDOME can only provide after sales service for products purchased directly from AZDOME. If you have purchased from a different seller, please contact them directly for service or warranty issues.



**info2@azdome.hk**

---

## •» NOTICE

---

Please read and understand warnings & safety instructions before operating.

- ① Make sure to always keep the camera plugged into the power, because camera's internal battery is NOT meant to last more than 3-5 minutes depending on the video resolution you choose.
- ② You will need to insert a memory card before you can start recording. Please insert only a brand name Class-10 or above higher speed Micro-SD card.
- ③ Before first time use, you MUST format the memory card in the camera to prevent any errors and for smooth operation.
- ④ Setting Date & Time: Please set the correct date and time, please refer to page EN-14.

## » SPECIFICATION

Model	AR09
Mic/Speaker	Built In
Photo Format	JPG
Video Format	MP4
Video Resolution	Front:1440P;1080P Rear:1080P
Memory Card	Class 10 or above high-speed Micro SD card
Car Inverter DC	5V/3.0A
Relative Humidity	10%-70%
Battery	500mAh lithium battery
WiFi	Yes. AZDOME APP
GPS Track	Support, need to connect GPS Module
Loop Recording	Support
Motion Detection	No
Parking Monitor	Support, 24 hours Parking Monitor need to connect 3-lead hard-wire kit

## » PACKING LIST



Mirror Dash cam



Rear Dash cam (6M cable)



USB Car Charger  
(3.5M Cable)



4 Rubber Fasteners



5 x Cable Clips



Wire Trim Tool



Anti-glare Screen Film



User Manual



Cleaning Cloth



Dry Wet Cloth Pack

### Note

· To improve the performance of the product, the contents of this manual are subject to change without prior notice.

## » PRODUCT DIAGRAM

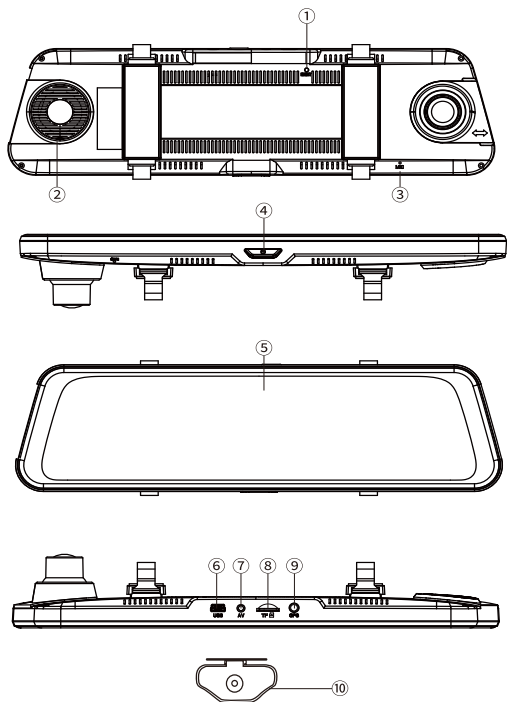

#	Component	Description
1	Reset	Insert a pin to 'RESET' hole to reboot when device is Not Responding
2	Speaker	Built in speaker
3	Microphone	Records audio
4	Power Key	-Press once to turn on device -Press and hold 3 seconds to turn off device -Short press to turn off/on screen when recording
5	Screen	Touching Screen
6	Mini USB Port	Connect to MINI USB cable & charge battery
7	AV-IN	Connect to rear camera
8	Micro SD Card Slot	Support Micro SD, Class 10 or above, U3 high-speed
9	GPS	Check your route when you playback the videos Via AZDOME Player
10	Rear Camera	Records rear side

## »» INSTALLATION

### Install Micro SD Card

1. Make sure the dash cam is turned OFF.
2. Insert the Micro-SD Card half way in ( GOLD Contacts - Facing the Back/Lens Side)
3. Now gently push the card in until it clicks & looks in place.
4. Must use only Brand Name, Class-10, U3 or higher speed Micro-SD Card.

### Remove Micro SD Card

-To remove the Micro SD card, gently push its top edge inward until it clicks, and then pops out, then simply pull it out of the slot.

#### MOST IMPORTANT about Memory CARD

1. Do not remove or insert Micro SD card when the camera is powered on which may damage the memory card.
2. Every time you insert a Micro SD card, please format it in the camera to ensure that the microSD card is compatible with the camera.

### Front Camera Installation

1. Turn off the car's engine. Insert a Micro SD card into the Micro SD slot of the dash cam.

2. Loop the rubber fasteners over the top fastener clips (There are 2 types of fasteners; please use which ever suits your car; Put the mirror dash cam in position on the front face of your existing rear view mirror ensuring the camera lens clears the edge of your rear view mirror. Loop the bottom rubber fasteners over the mirror and attached to the bottom fastener clip.

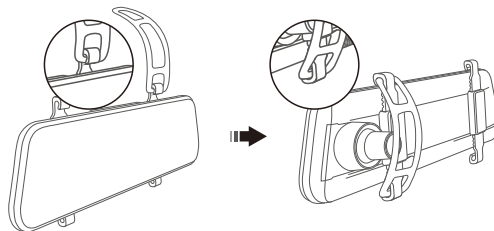

3. Connect one end of Car Charger cable to the USB Input port on the topside of Mirror Dash Camera. Plug the other end of the Car Charger cable to the Cigarette Lighter Receptacle in the vehicle. Run the cable along your vehicles console.
4. Connect the GPS module to the dash cam, tear off the sticker of GPS module and place it on the car dashboard.

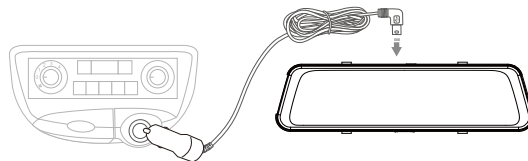

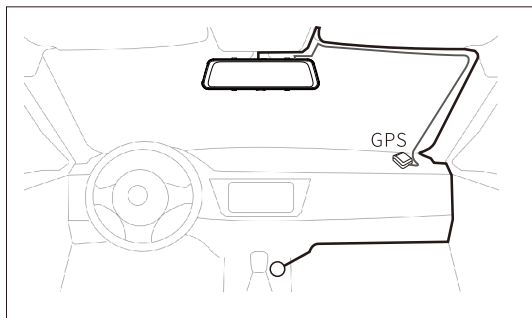

### Rear Camera Installation

The rear camera equipped with a 6-meter cable is to connect to the dash-cam via AV IN port. Before installation, please check if the provided cable is long enough to reach the rear cam in your car.

1. There are two locations for mounting the rear camera: rear windshield / above the number plate.

Position 1: Install the rear camera on the rear windshield.

Position 1 is designed for live stream rear review only, not for reversing guide.

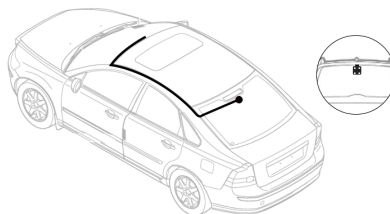

Position 2 (Recommended): Install the rear camera near the license plate. Feed the camera wire through to the interior of the vehicle either by drilling a new hole; or using the existing hole for the number plate light if possible. The two included screws and double-sided tape will hold the camera in place. The rear camera image is crisp and clear for both rear viewing and reversing guide.

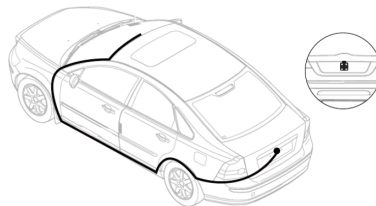

To use the reversing function, install the rear camera in position 2, then connect the red cable of the rear camera extension cable to the anode of the car reversing lamp by using a test light or multimeter to determine which wire is positive.

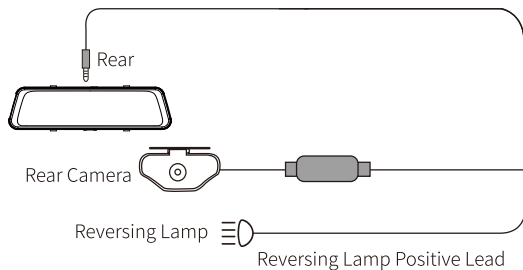

2. Once all of the plugs are connected and power connections are made. Switch on the ignition. Shift the gear into reverse, and if all is wired correctly; the rear camera image will appear in your mirror.

#### Note

- ① Please clean the position to ensure the adhesive quality before install the rear camera.
- ② Please clean the rear windshield regularly to ensure the image quality if choose the position 1.
- ③ If choose the position 2, you can install the rear camera with the included adhesive sticker or screws.
- ④ Please fasten the screws to adjust the desired camera view angle.

## » GET STARTED

### Power On/Off

Option 1: Start the engine to automatically power on the Mirror Dash Camera; stop the engine to automatically power it off.

Option 2: Press once to turn on device; Press and hold 3 seconds to turn off device.

### Screen On/Off

Simply press the Power Button once to switch the screen off (But can still recording) when the mirror dash cam is ON; Press it again or tap the touch screen to wake up the camera.

### FORMATTING MEMORY CARD

1. Touch  to enter the Settings Menu.
2. Touch "System" and touch "Format".
4. Touch "OK".

#### Note

1. Do not remove or insert Micro SD card when the camera is powered on which may damage the memory card.
2. Every time you insert a Micro SD card, please format it in the camera to ensure that the microSD card is compatible with the camera.



## SETTING TIMEZONE AND DATE/TIME

① Please connect GPS module.

② Set the GMT value first.

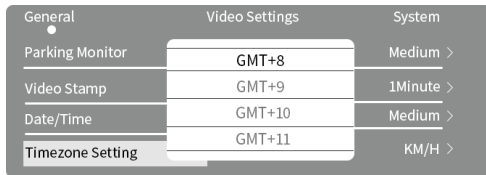

③ Set the Date/Time: Year-Month-Day-Hour-Minute

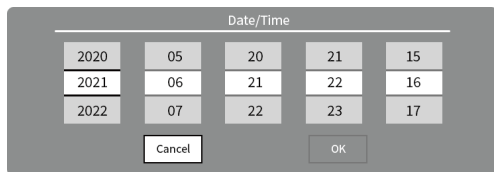

The dash camera will updated the date and time based on the GMT value selection automatically when it receives the GPS signal .







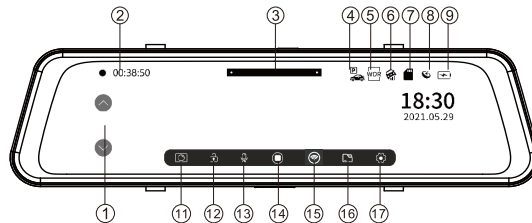

	British Winter Time	British Summer Time
<b>UK Time Zones</b>	GMT/UTC +1	GMT/UTC ±0

Go to <https://www.timeanddate.com/time/map/> to find out your Correct GMT (Greenwich Mean Time) value based on your location.

## ▶▶ BUTTON FUNCTION



#	Description	Feature
1	Adjust View Angle	Tap   to adjust view angle, can't work when dual camera display
2	Recording timer	Shows the elapsed recording time
3	Screen Brightness Control	Slide the brightness bar to increase or decrease the screen brightness
4	Parking Monitor	Shows the parking mode status
5	WDR	Shows the WDR status
6	G-sensor	Show the G-sensor status

7	MicroSDCard	Show the Micro SDCard status
8	GPS	Show the GPS status
9	Battery	Shows the status of Battery
10	Date/Time	Shows the date and time
11	PhotoShooting	Tap  to capture a photo and save it to the memory card
12	EmergencyLock	Tap  to manually lock the current video that is recording to make sure it will NOT be overwritten or deleted; Tap  to start recording again
13	Audio	Tap  to mute/unmute the microphone
14	Recording	Tap  to end & save the recording into the memory card
15	WiFi	Tap  to turn on WiFi Tap again, turn off wifi
16	Playback	Tap  to enter playback menu and check all videos or photos saved
17	System Setting	Tap  to enter system setting menu

## FUNCTION

### General

#### Parking Monitor — On/Off(Default)

If connected to cigarette lighter to supply power, with "Parking Monitor" function enabled, dash cam automatically starts recording a video for around 60s and lock it when any collision/ impact detected. Dash cam use its internal battery(500mAh) to detect any knock or bump so supports limited times of recording a 60-second video. This mode greatly saves energy and protects your car battery.

If you want to use 24-hours Parking Monitor please take refer to Page EN-14

#### G-sensor — Off/ High/ Medium(Default)/ Off

G-Sensor is a 3-axis impact gravitational accelerometer which is designed to detect physical and gravitational forces on the camera. While Video is Being Recorded: In the event when G-Sensor is triggered due to physical or gravitational impact force on the camera, the current loop cycle length of video file will be locked so it will NOT be deleted by loop cycle function.

### **Video Stamp — On(Default)/Off**

This stamps menu allows you to choose your choice of stamps for the bottom of the video. Date & Time, speed, GPS Coordinates, AZDOME Logo and model.

### **Screen Saver — 1(Default)/3/5 minutes/ Off**

1/3/5 minutes: The dash cam LCD screen will turn off after 1/3/5 minutes, but still recording.

Off: The dash cam LCD screen will always on.

### **Timezone**

From GMT-12 to GMT+12 timezone.

### **Time/Date Setting**

To set the date & time.

### **Button Sound — Off/ Low/ Medium(Default)/High**

This feature allows you to turn ON/OFF camera button's beep sound & any voice confirmation.

### **Speed Unit— KM/H(Default)/MPH**

You can choose desired speed option stamp to be displayed and recorded on video stamp based on your selection.

### **Frequency — 50HZ/ 60HZ(Default)**

Here you should choose the frequency accordingly to your power supply specification used in your country based on your geographical location.

60 Hz (USA – North America)

50 Hz (Europe – Most Asian Countries)

### **Format Remind — Off/ 15days/ 30days(Default)/ 60days**

This feature allows you to set a FORMAT REMINDER to format your memory card. Once set, the camera will remind you to format your memory card at a set interval.

### **Parking Guide Line — On(Default)/Off**

On: The function is activated when the reverse gear is selected. The camera image is shown on the dash cam screen with assistance line.

Off: The function is activated when the reverse gear is selected. The camera image is shown on the dash cam screen but NO assistance line.

### **Rear Video Mirror — On(Default)/Off**

On: The image on the dash cam screen matches that of your rear-view mirror.

### **Time Lapse Parking Mode — On/Off(Default)**

This menu will be shown when ONLY connected to 3-lead hardwire kit.

Time Lapse Parking Mode ON: Dash cam will capture photos at 1 frame per 1s, and stitches them into a video which greatly optimizes the use of memory card.

### **How to set 24-hours Parking Mode**

If you connect to AZDOME 3-lead hard wire kit, here are two 24-hours Parking Modes that you can select from:

1. When function “Parking Mode” ON / “Time Lapse Parking Mode” OFF: Dash cam will record unlimited times of a 60-second video then power off whenever detecting collision/impact.

This mode is ideal if you: Parked in a quiet area or want audio in all circumstances

- ① When you turn OFF the car’s engine. Then the camera will also power off.
- ② Dash cam automatically starts recording a video for around 60s and lock it when any collision/impact detected
- ③ When you start your car for the next time, the camera will power on and goes into normal video - Loop Recording Mode automatically.

2. When “Parking Mode” OFF / “Time Lapse Parking Mode” ON: Dash cam will capture photos at 1 frame per 1s, and stitches

them into a video which greatly optimizes the use of memory card.

This mode is ideal if you :

-Parked in a busy area with lots of vehicle and foot traffic (ie. mall parking lot)

-Want to have a quick overview of everything that happens around your parked car.

① When you turn OFF the car’s engine. Then the camera will STOP the Loop Recording and it will go into the Time Lapse Parking Mode automatically.

② While this Time Lapse Parking Mode is being recorded, If someone hits your car, then the camera will lock the video file, then saved in LOCK folder of Micro SD card > then go on Time Lapse Parking Mode recording.

③ When you start your car for the next time, the camera will automatically STOP the Time Lapse Parking Mode. Then it will go into normal video - Loop Recording Mode automatically.

### **NOTE:**

-The Time Lapse Mode video files plays at faster speed and NO audio when playback.

-If function “Parking Mode” and “Time Lapse Parking Mode” are ON simultaneously, the Time Lapse Parking Mode will be the priority

## Video Settings

### Video Resolution — 1440(Default)/1080P30

Allow to choose the desired video resolution. Higher resolution and fps videos result in smoother videos, but also take more storage space.

### Loop Recording — 1min/ 3mins(Default)/ 5mins

Allow the dash-cam to continuously record. Please notice: the dash-cam will keep deleting the oldest files automatically when memory card gets full so that it can keep recording over and over. Here select the length of video file for the loop recording.

### WDR — On(Default)/Off

Wide Dynamic Range (WDR) improves the exposure by taking the combinations of over exposed and under exposed image into one robust wide range of lighting with higher depth image.

### Time-lapse Record — On/Off(Default)

Time Lapse recording mode allows you to capture specific images per second at a much lower rate. So when you combine and play those images at the normal 30fps rate, everything seems to be moving faster in time lapse.

## System

### Language — Multilingual, default English.

Allow to choose your desired language for dash-cam system.

### GPS Info

Show the satellite numbers, Date/Time, Longitude, Latitude, Speed, Direction.

### WiFi

Default turn off WiFi. If turn on WiFi, it can connect AZDOME APP which download on APP and operation on AZDOME APP.

### Format

This feature will allow you to format inserted memory card, all the data will be deleted.

We recommend that you format the memory card every 3 months to keep it clean for smooth operation.

Please note that memory cards have their self life span, after so many uses of writing data over and over, eventually they will become inoperable. When that happens, please replace your memory card.

your camera. You will need this information in the future to check if newer version of firmware is available.

Please visit: <http://www.azdome.hk/downloads.html> for latest firmware upgrade instructions.

## Reset Settings

Here you can restore all the settings to factory default settings.

## Version

Here you can check the current firmware version installed on

## ▶▶ PLAYBACK RECORDED VIDEOS

There are 2 different way you can access your videos.

### A. On Dash Camera

Tap  to enter Playback Menu, you will see six folders.

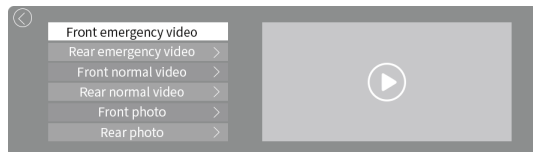

Front emergency video : emergency videos recorded captured by front camera but can't be overwritten

Rear emergency video : emergency videos recorded captured by rear camera but can't be overwritten

Front normal video : videos recorded captured by front camera



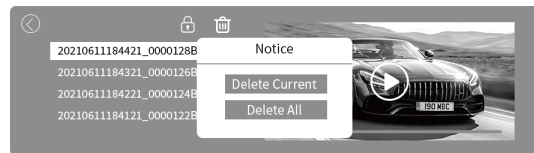
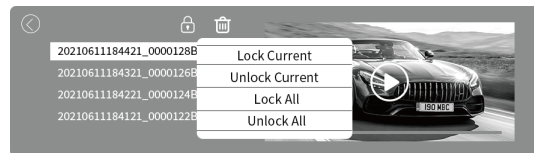

Rear normal video : videos recorded captured by rear camera

Front photo : photos captured by front camera

Rear photo : photos captured by rear camera



## Tips

1. Tap  to return to the previous interface
2. Tap  to play/pause the video file.
3. Tap  to manually lock/unlock the current video that is recording to make sure it will or NOT being overwritten or deleted. recording to make sure it will or NOT being overwritten or deleted.
4. Tap  to delete the selected file or ALL files.

**Note:**The photo file can NOT be locked.

## B. On Computer

1. Please remove the Micro SD card from camera and insert it directly in your laptop if you have a Micro SD Card slot (otherwise please using a Micro SD Card reader).
2. You should be able to see drive "D" or "E" or other name depending on the pre-installed hard drives. Once you find the added flash drive, double click in it, then you will see the file folders- Movie / LOCK / Photo
- Movie: The loop recording video files that can be overwritten.
- LOCK: The video file will be locked so it will NOT be deleted by loop recording function.
- Photo: The pictures
3. Then simply double click on the video to play them.

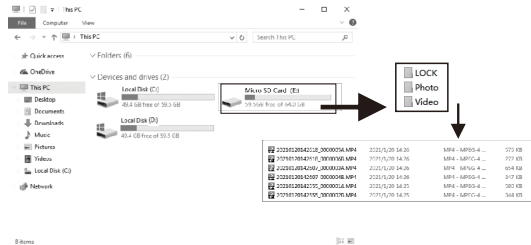

File named \*\*\*\*\*A=videos or photo captured by front camera

File named \*\*\*\*\*B=videos or photo captured by rear camera

## GPS PLAYER SOFTWARE INSTALLATION (PC/MAC ONLY)

1. Go to our website [www.azdome.hk/downloads](http://www.azdome.hk/downloads) to download the AZDOME Player (For Windows32bits/64bits or macOS)
2. Install the AZDOME Player in your laptop, photo as below;
3. Play the video files by AZDOME Player, you can see the car route on Google Map.

AZDOME Tech Support : [service@azdome.hk](mailto:service@azdome.hk)

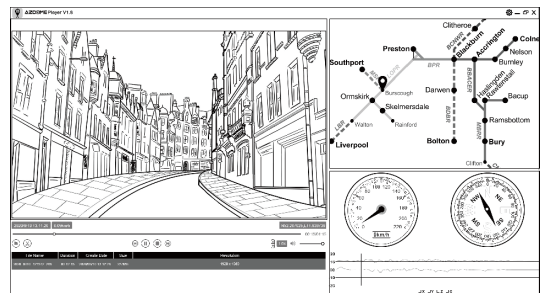

---

## •» FAQ

---

### **Q1:Why the rear cam image is converse on the screen?**

According to your habit, please use the function called “Backup Cam Mirror Image” .

### **Q2:Poor image quality of rear cam**

The most likely cause is simply a dirty lens. Since many cameras are mounted low on the back of the car, they're subject to being obscured by mud, snow, dirt or other debris. Luckily, the fix is easy: Clean the lens with a soft cloth (to prevent scratching the lens).

If still doesn't work, please e-mail to [service@azdome.hk](mailto:service@azdome.hk) with order number.

### **Q3:Dash cam will be hot**

Yep! A dash cam of this caliber is a pretty high-tech piece of equipment. When you think about it from an engineering perspective, capturing high quality full HD video takes a large amount of computer processing power. Heat is the by-product of all that data processing that is going on.

But not to worry.The case of the Dash cam itself is actually used as a heat-sink (notice the nice vents), so that's why you may notice it is warm or hot to the touch. Don't worry, this is normal,

and your AZDOME is operatin as desi ned.

### **Q4:My Video playback on PC is lagging.**

You are viewing high-bit rate version of video files. General computer configuration may have problem with faster data processing. Please record videos at lower resolution and try again. Contact us if problem still exists.

### **Q5:Why dash cam can't get the GPS signal?**

1. Depending on the vehicle and the location of the GPS signal can be blocked due to strong radio interference of other electronic devices in the car, the cloudy/rainy weather or mountains, tunnels, tall buildings on both sides of road etc.
2. Please check if GPS works by taking the GPS Module from the car to outside. If it works then there must be a heavy interference in the car, for example thick car Explosion-proof membrane, metal item and etc.

---

## •» DISCLAIMER

---

AZDOME Streaming Mirror Dash Camera is designed to be use as a driver's assistant, it dose NOT remove the responsibility of driving the vehicle from the driver. The legal responsibility and safe driving practice always remains with the driver.



You agree to use this product and understand that this is to be used as aid only. We highly recommend that you have this product professionally installed to ensure that it will provide the function it is set out to perform. In case of you change your mind or return of this product, company is NOT responsible in anyway for the holes or installation modifications made to your vehicle.

---

## •» WARNINGS

---

- Do not expose this product to rain, moisture or water under any circumstances or it will result in external or internal damage.
- Do not put the unit in a damp environment. This device is not designed to be damp proof.
- Do not try to open the cover or try to repair it yourself. If the accessories for this device have any problem, please contact the seller for assistance.
- Do not expose this device to an excessive heat, dust or use any chemical substance or cleaning solvent to clean this device.
- Do not operate or install the camera while driving, or attempt to change any setting etc. Pull off the road first and only do so when it is safe.
- Do not drop, puncture or disassemble this product or dispose it on fire. It contains Battery and can explode if improperly

handled.

- Do not use the charger if the cord is broken or damaged. Keep out of reach of children.
- Do not leave the camera in the direct sunlight for a long period of time or where temperature could go above 140°F (60°C).
- Removing the camera from the vehicle when not in use is recommended. This prevents likelihood of theft or exposure to excessive heat to prevent damage to unit.