

ASSEMBLY INSTRUCTIONS

POOL TABLE ASSEMBLY

WARNING: TWO ADULTS NEEDED TO ASSEMBLE POOL TABLE

1. ASSEMBLY THE SIDE LEG PANEL AS SHOWN IN **figure 1**.
2. ATTACH EACH LEG **P2A** AND **P2B** TO THE TABLE WITH BOLTS **H1** AND WASHERS **H2**.
3. ATTACH THE LEG END PANELS **P3** TO THE LEGS USING BOLTS **H3**, WASHERS **H4** . AS SHOWN IN **figure 1**.
4. ATTACH THE SIDE PANELS TO THE END PANEL USING BOLTS **H3**, WASHERS **H4**, AS SHOWN IN **figure 1**.

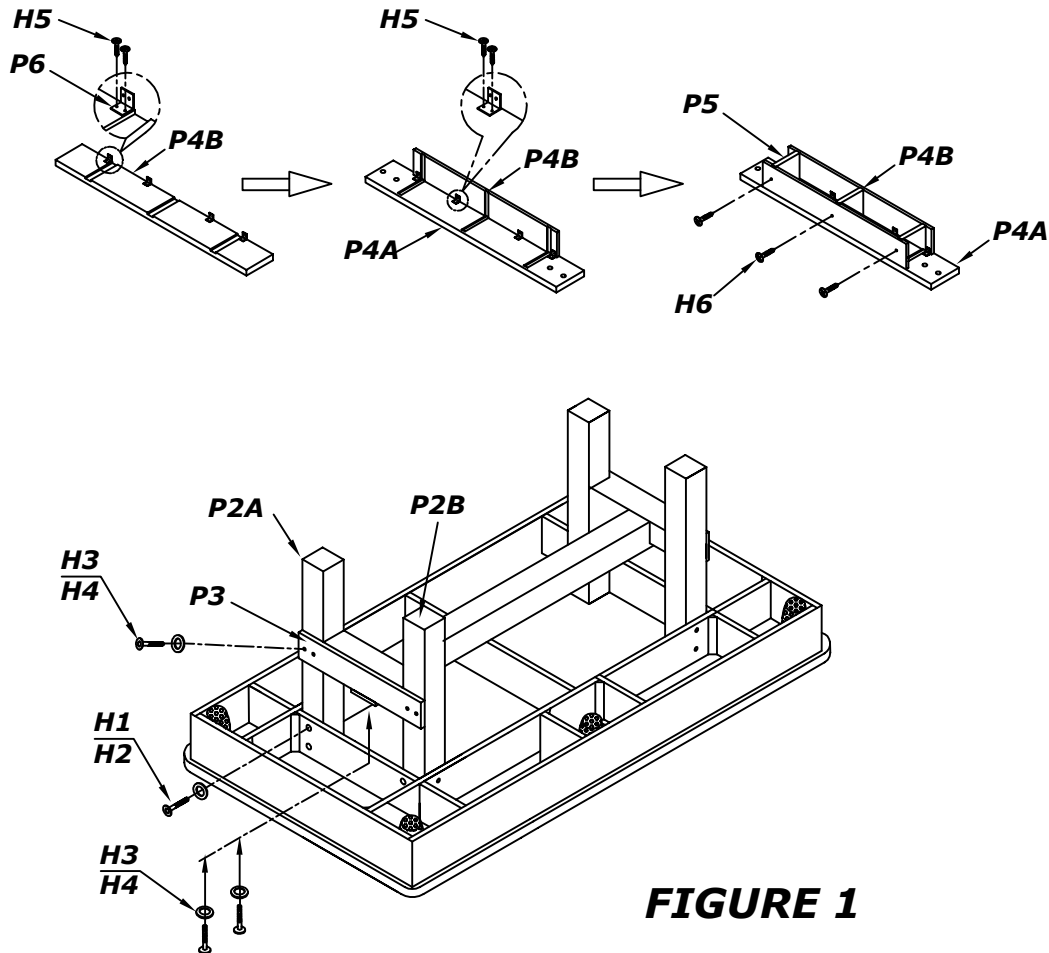
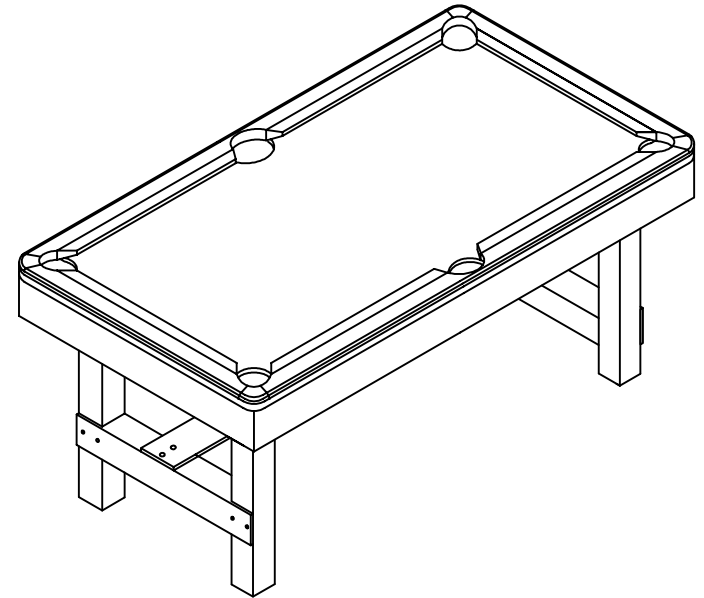

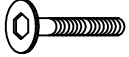





FIGURE 1

POOL TABLE ASSEMBLY INSTRUCTIONS **PEGASI**







PARTS IDENTIFIER

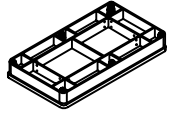
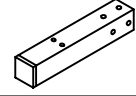
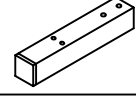

HARDWARE (ACTUAL SIZE MAY VARY)

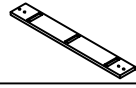
		DESCRIPTION	QTY
	H1	5/16" BOLT	16
	H2	5/16" WASHER, FLAT BLACK	16
	H3	1/4" BOLT	12
	H4	1/4" WASHER, FLAT BLACK	12
	H5	1/2" ROUND HEAD SCREW	32
	H6	1" ROUND HEAD SCREW	6







ASSEMBLY PARTS (ACTUAL SIZE MAY VARY)

	P1	MAIN CABINET	1
	P2A	LEFT LEG	2
	P2B	RIGHT LEG	2
	P3	LEG END PANEL	2
	P4A	LEG SIDE PANEL A	1
	P4B	LEG SIDE PANEL B	2

PARTS IDENTIFIER

		DESCRIPTION	QTY
	P5	WOOD	3
	P6	BRACKET	8

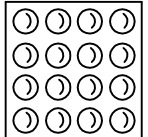
ACCESSORIES

	A1	CUE STICK	2
	A2	TRIANGLE	1
	A3	CHALK	2
	A4	BRUSH	1
	A5	BILLARD SET	1
	A6	ALLEN WRENCH	1