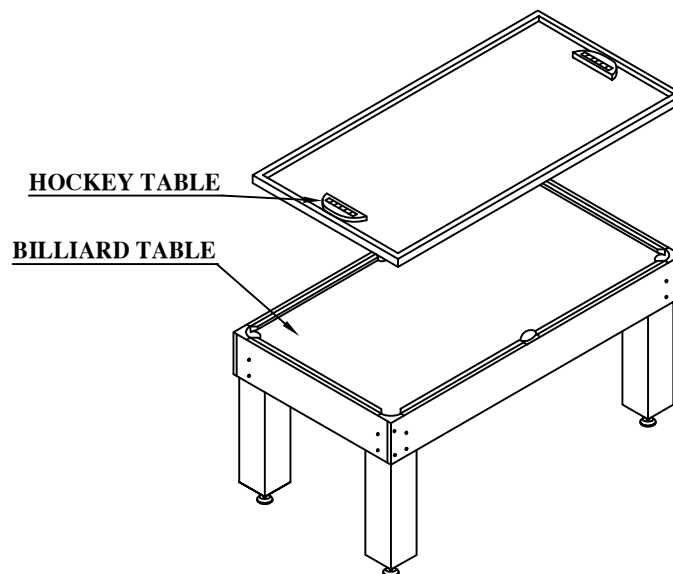
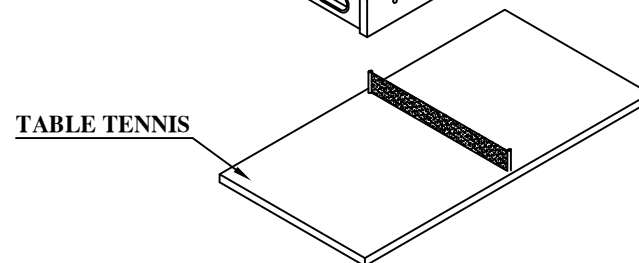
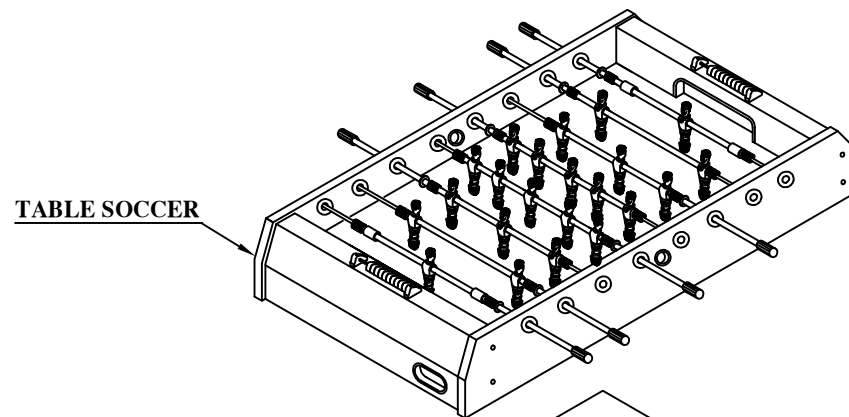

TABLE SOCCER

ASSEMBLY INSTRUCTIONS



PARTS IDENTIFIER

ASSEMBLY PARTS

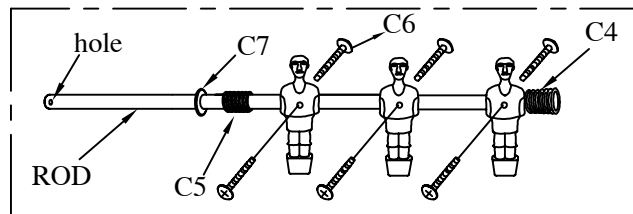

R1

5 Home Players Rod

1

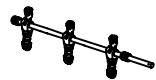

R2

3 Home Players Rod

1



R3

2 Home Players Rod

1

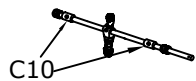

R4

1 Home Player Rod

1



R5

5 Away Players Rod

1



R6

3 Away Players Rod

1



R7

2 Away Players Rod

1

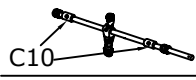

R8

1 Away Player Rod

1

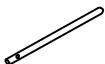





R9

Solid Rod
(INSERT THE PLAYERS ROD)

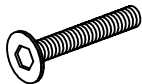

8

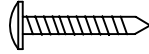
PARTS IDENTIFIER

HARDWARE







	DESCRIPTION	QTY.
	H1 1/4" X 1" BOLT	24
	H2 1/4"WASHER	24
	H3 1-1/2" ROUND HEAD SCREW	4
	H4 1"FLAT HEAD SCREW	4
	H5 CYLINDRICAL NUT	4

ACCESSORIES

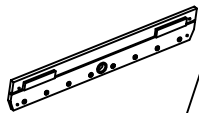
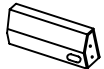
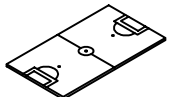
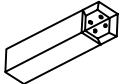
	DESCRIPTION	QTY
	A1 SOCCER BALL	2
	A2 TOOL	1

PARTS IDENTIFIER

ASSEMBLY PARTS

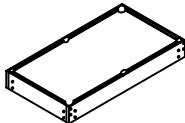
	DESCRIPTION	QTY. REQUIRED (EXTRA PIECES MAY BE INCLUDED)
	P1 SIDE PANEL	2
	P2 END PANEL	2
	P3 PLAYING FIELD	1
	P4 LEG	4
	P5 PLAYFIELD SUPPORT BRACE	2
	P6 ROD HANDLE	8
	P7 PLASTIC NUT	8
	P8 PLASTIC BOLT A	8
	P9 PLASTIC BOLT B	8
	P10 LEG LEVELERS	4
	P11 BILLIARD TABLE	1

ASSEMBLY INSTRUCTIONS

SOCCER TABLE ASSEMBLY

WARNING: TWO ADULTS NEEDED TO ASSEMBLE SOCCER TABLE

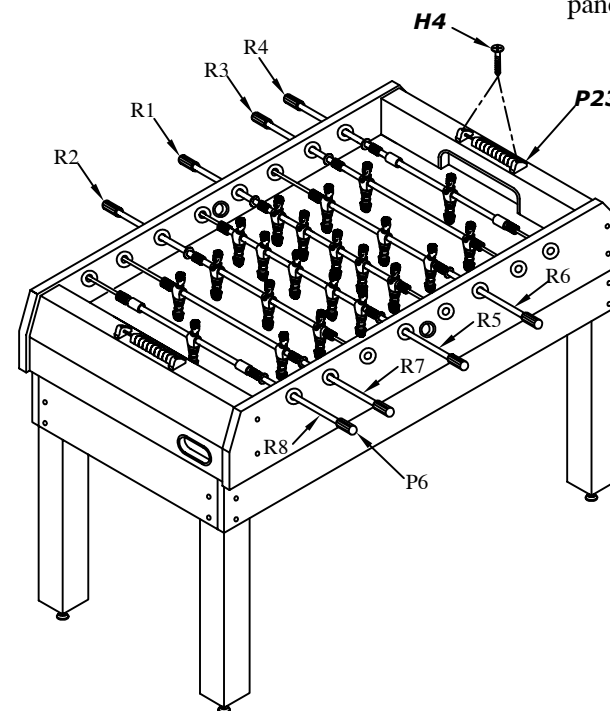
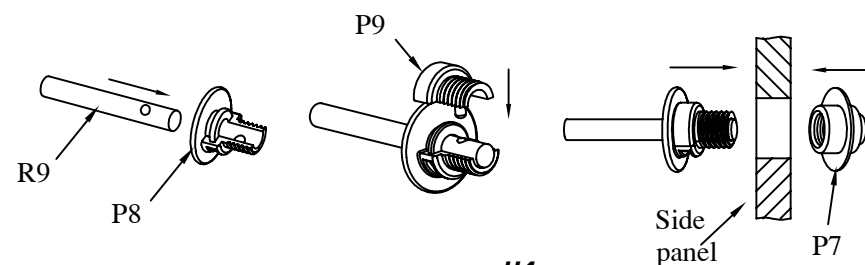
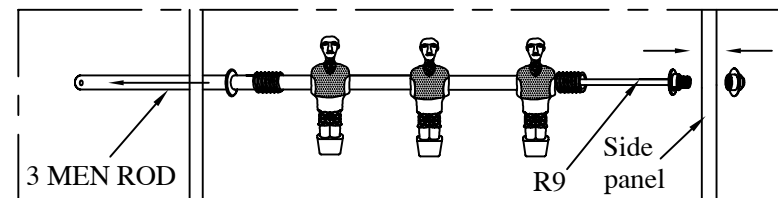

ASSEMBLY INSTRUCTIONS

SOCCER TABLE ASSEMBLY

WARNING: TWO ADULTS NEEDED TO ASSEMBLE SOCCER TABLE



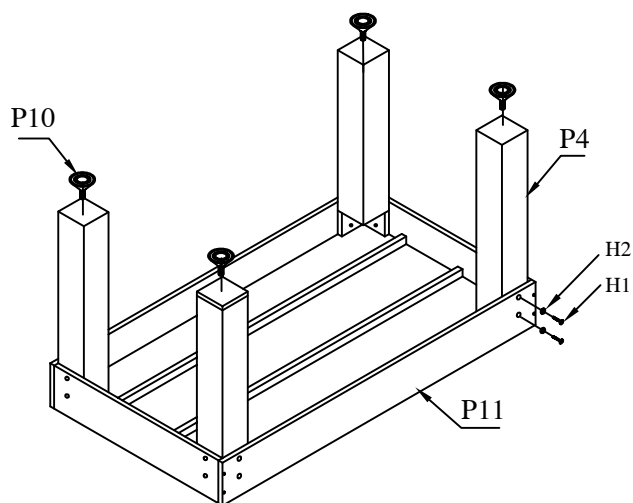





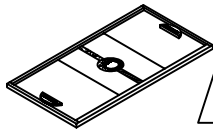

5. ASSEMBLE EACH LEG (P4) ATTACH WITH BOLT (H1) AND WASHER (H2).
 MAKE CONNECTIONS FINGER TIGHT.
 ATTACH THE LEG LEVELERS (P10) INTO BOTTOM OF LEGS .

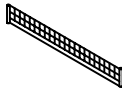

6. INSERT THE PLAYERS ROD **R1~ R8** THROUGH THE HOLE OF THE TWO SIDE PANELS FROM THE INSIDE TO THE OUTSIDE IN POWER.
7. INSERT THE RODS **R9** IN THE PLASTIC BOLT **A P8**, BE SURE THE HOLE OF ROD MUST FACE THE HOLE OF **P8**, PUT THE PLASTIC BOLT **B P9** INTO THE HOLE OF THE ROD AND PLASTIC BOLT **A P8**, THEN INSERT THE ASSEMBLED ROD IN THE HOLE OF SIDE PANEL, TIGHTEN THE PLASTIC NUT **P7**.
 * Do not over tighten **P7**.
8. ATTACH THE TWO SETS OF SLIDE SCORER (**P23**) TO THE END OF TABLE WITH SCREWS **H4**.
9. ATTACH THE ROD HANDLE **P6** ONTO THE ENDS OF THE RODS.







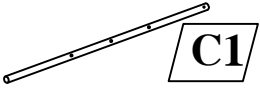
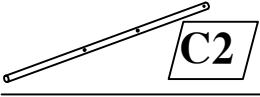
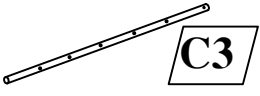

PARTS IDENTIFIER

ASSEMBLY PARTS

	DESCRIPTION	QTY. REQUIRED (EXTRA PIECES MAY BE INCLUDED)
 P12	HOCKEY TABLE	1
 P13	HOCKEY STRIKER	2
 P14	HOCKEY PUCK	2
 P15	MINI TABLE TENNIS NET	1
 P16	TABLE TENNIS PADDLE	2
 P17	TABLE TENNIS BALL	2
 P18	CUE STICK	2
 P19	BILLIARD BALL	1
 P20	CHALK	2
 P21	TRIANGLE	1
 P22	BRUSH	1
 P23	SLIDE SCORE	2

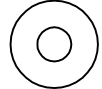
PARTS IDENTIFIER

ASSEMBLY PARTS

	DESCRIPTION	QTY
	C1 3 PLAYER ROD	4
	C2 2 PLAYER ROD	2
	C3 5 PLAYER ROD	2
	C4 Rod Springs (A)	8
	C5 Rod Springs (B)	8
	C6 BOLT	52
	C7 PLASTIC ROD WASHERS	8
	C8 AWAY MEN	11
	C9 HOME MEN	11
	C10 STOP RING	4

ASSEMBLY INSTRUCTIONS

SOCCER TABLE ASSEMBLY

WARNING: TWO ADULTS NEEDED TO ASSEMBLE SOCCER TABLE

1. SLIDE THE PLAYING FIELD (P3) WITH PLAYING SURFACE GRAPHICS FACING DOWN INTO THE SLOTTED OF INSIDE OF THE TWO SIDE PANELS .

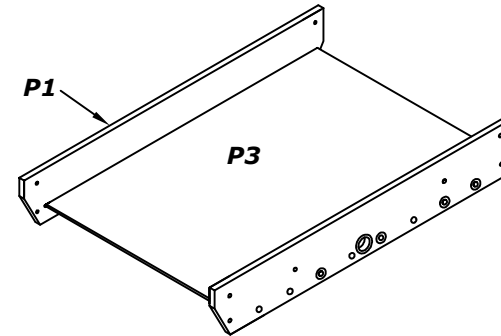

2. INSERT THE NUT (H5) INTO THE HOLE OF THE SUPPORT BRACES (P5).
3. ASSEMBLE THE TWO END PANELS(P2)WITH BOLTS(H1) AND WASHERS (H2).
4. ASSEMBLE THE FIELD SUPPORT BRACE(P5) ON THE PLAYING FIELD(P3) WITH SCREW(H3).

