



Meaningful Innovation.

WEEE Number: 80133970

# INSTRUCTION MANUAL

## FABRIC BELT SERIES LIGHTS



LED DOWN LIGHT  
VT-41120



LED GLOBE LIGHT  
VT-41010



LED DOWN LIGHT  
VT-41020



LED SPOT LIGHT  
VT-41012

LED DOWN LIGHT  
VT-41112

**03** YEAR  
**WARRANTY\***

### TECHNICAL DATA

MODEL	VT-41012		VT-41112		VT-41010	VT-41020		VT-41120	
SKU	23104	23105	23106	23107	23108	23109	23110	23111	23112
UNIT COLOR	Black	White	Black	White	Black	Black	White	Black	White
WATTS	12W				10W	20W			
LUMENS	800 Lm	900 Lm	800 Lm		900 Lm	1400 Lm	1700 Lm	1200Lm	1100Lm
COLOR TEMPERATURE	3000K								
INPUT VOLTAGE	DC: 48V								
BEAM ANGLE	38°		120°						
LIFE SPAN	25,000 Hours								
ON/OFF CYCLE	>15,000 Times								
PROTECTION RATING	IP20								
CRI	90								
MATERIAL	Aluminium								
DIMENSION	Ø100x107 mm		Ø100x107 mm		Ø150x147 mm	Ø200x113 mm		Ø300x71 mm	

In case of any query/issue with the product, please reach out to us at: [support@v-tac.eu](mailto:support@v-tac.eu)  
 For More products range, inquiry please contact our distributor or nearest dealers.  
 V-TAC EUROPE LTD. Bulgaria, Plovdiv 4000, bul.L.Karavelow 9B

## INTRODUCTION & WARRANTY

Thank you for selecting and buying V-TAC product. V-TAC will serve you the best. Please read these instructions carefully before starting the installation and keep this manual handy for future reference. If you have any other query, please contact our dealer or local vendor from whom you have purchased the product. They are trained and ready to serve you at the best. The warranty is valid for 3 years from the date of purchase. The warranty does not apply to damage caused by incorrect installation or abnormal wear and tear. The company gives no warranty against damage to any surface due to incorrect removal and installation of the product. The products are suitable for 10-12 Hours Daily operation. Usage of product for 24 Hours a day would void the warranty. This product is warranted for manufacturing defects only.

## WARNING

1. Please make sure to turn off the power before starting the installation.
2. Installation must be performed by a qualified electrician.
3. The light source of this luminaire is not replaceable, when the light source reaches its end of life the whole luminaire should be replaced.
4. Proper grounding should be ensured throughout the installation.
5. The lights works on DC 48V, please connect correctly with the driver before connecting the driver to the power supply main. **DO NOT CONNECT DIRECTLY TO THE MAIN SUPPLY.**
6. For Indoor use only



Points de collecte sur [www.quefairedemesdechets.fr](http://www.quefairedemesdechets.fr)  
Privilégiez la réparation ou le don de votre appareil !



This marking indicates that this product should not be disposed of with other household wastes.



Caution, risk of electric shock.

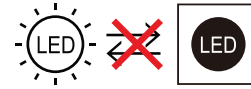

Non-replaceable light source

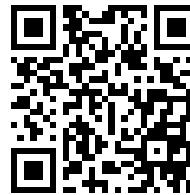

### COMPLETE INSTALLATION MANUAL QR CODE

Please scan the QR code to access the manual in multiple languages.

## A. MANDATORY ACCESSORIES (NOT INCLUDED - SOLD SEPARATELY)

<b>1</b>	
<b>FABRIC TRACK (BELT)</b>	
<b>SKU</b>	23125 - BEGONIA RED 23126 - DARK GRAY
<b>LENGTH</b>	10 M/Roll
<b>INCLUDES ACCESSORIES IN 10M/ROLL</b>	1 x Scissors 2x Screw Driver 2x Lock Opener

<b>2</b>	
<b>POWER SUPPLY (DRIVER)</b>	
<b>SKU</b>	23181
<b>INPUT VOLTAGE</b>	176-264V, 50/60Hz
<b>OUTPUT VOLTAGE</b>	48V, 2.08A
<b>WATTS</b>	100W Max Connect: 80-85W

RoHS



UK  
CA



## Different ways of installation

**3**



### SURFACE CANOPY

SKU	23127
DIMENSION	Ø205x 50mm
UNIT COLOR	Sandy Black

OR

**4**



### REMOTE RECESSED CANOPY

SKU	23130
DIMENSION	Ø100 x 72mm
CUT OUT SIZE	Ø90mm
UNIT COLOR	Sandy Black

OR

**5**

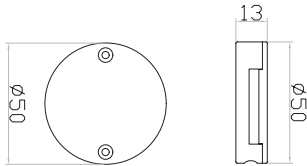

### RECESSED WIRE CONNECTOR

SKU	23131
CUT OUT SIZE	Ø 55MM
BLACK WIRE LENGTH (Max.)	1500 MM
UNIT COLOR	Sandy Black

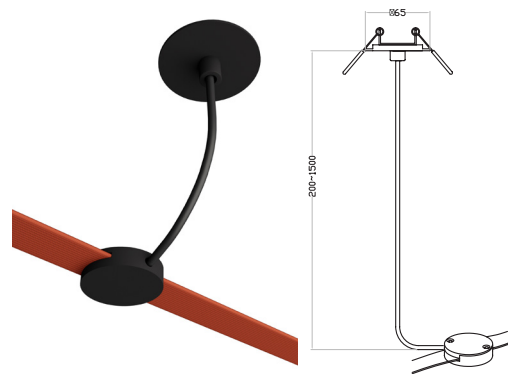

## B. OPTIONAL ACCESSORIES (NOT INCLUDED - SOLD SEPARATELY)

**1**

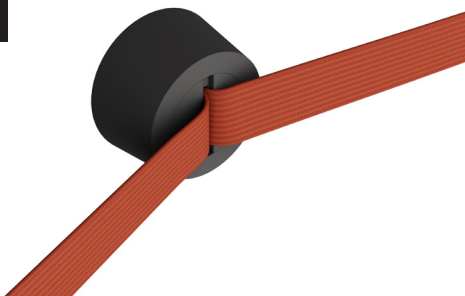

### CIRCULAR RATCHET FOR DOUBLE BELT

SKU	23129
DIMENSION	Up : Ø63MM Down : Ø75MM Height : 43MM
UNIT COLOR	Sandy Black

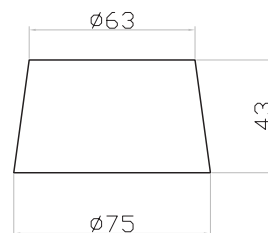
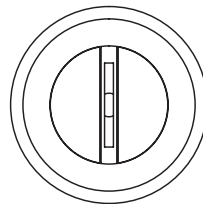

**2**

**COUNTER WEIGHT FOR FLOOR LAMP APPLICATION**

SKU	23132
DIMENSION	Ø60 x 117 x 130mm
UNIT COLOR	Sandy Black

**3**

**SUSPENSION CLIP**

SKU	23133
WIRE LENGTH	Max 1200mm
UNIT COLOR	Sandy Black

**4**

**BELT SUPPORT**

SKU	23135 (50PCS/Pack)
UNIT COLOR	Sandy Black

**5**

**BELT END CAP DOUBLE WIRES**

SKU	23136 (50PCS/Pack)
UNIT COLOR	Sandy Black

**6**

**BELT END CAP SINGLE WIRE**

SKU	23137 (50PCS/Pack)
UNIT COLOR	Sandy Black

## C. BASIC INSTALLATION

1

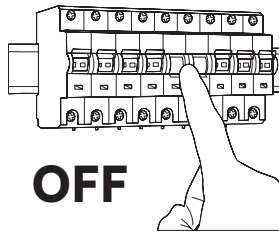

2

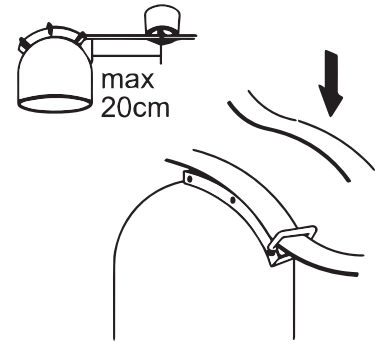
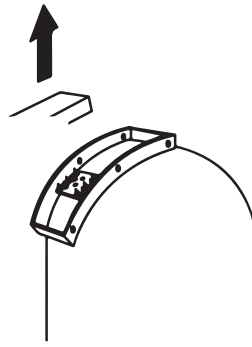

REPEAT

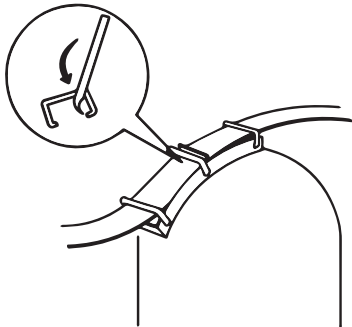
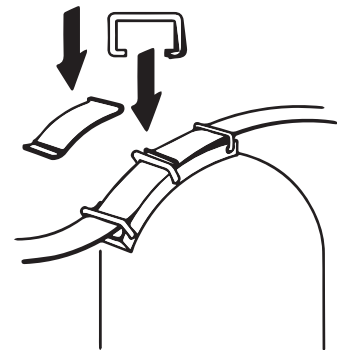
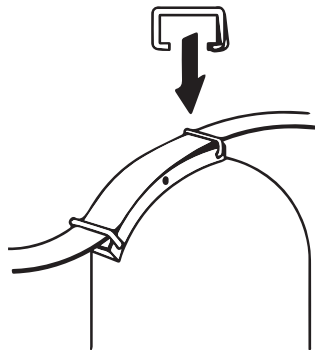
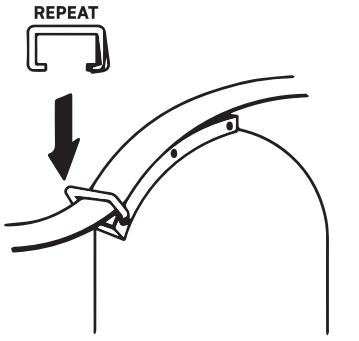

If Disassembly

### ACCESSORIES WITH BELT



For Belt  
Cutting



For Lamps  
Assembly



For Canopy  
Assembly

3

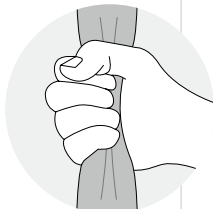

**BEFORE ATTACHING THE LUMINAIRE**  
Manual tension adjustment



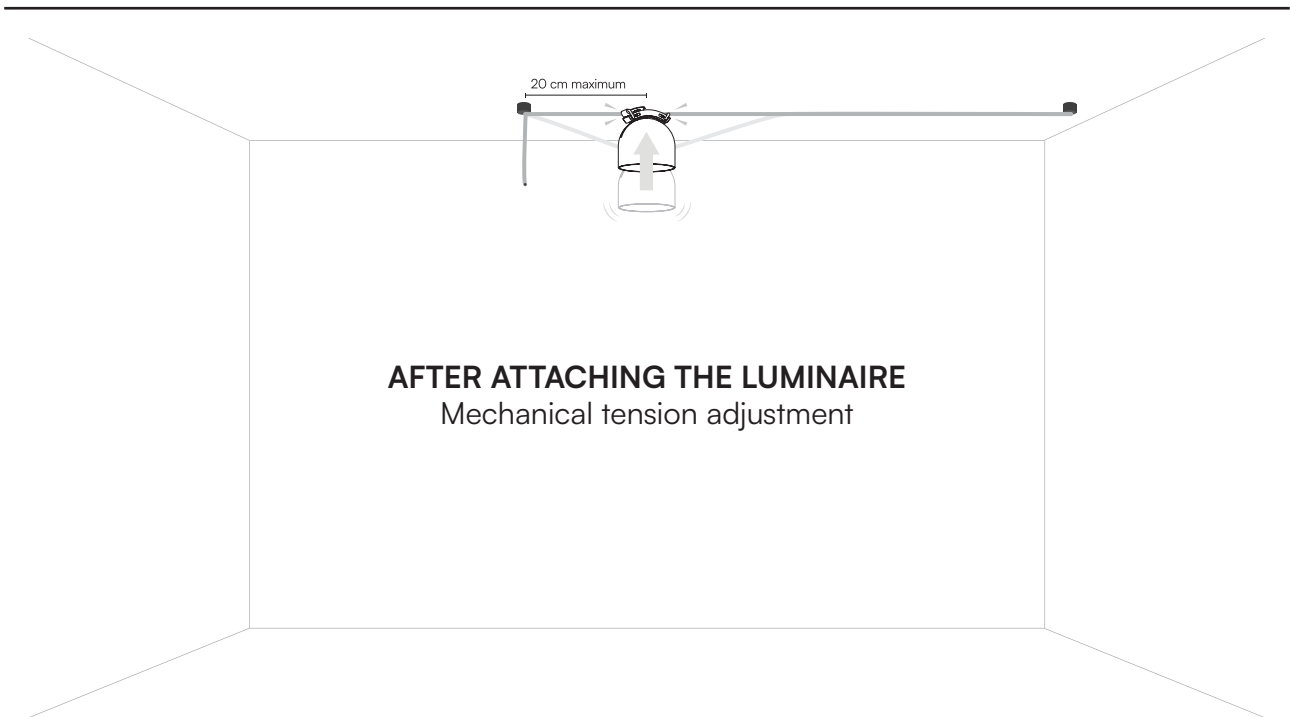

**AFTER ATTACHING THE LUMINAIRE**  
Mechanical tension adjustment

4

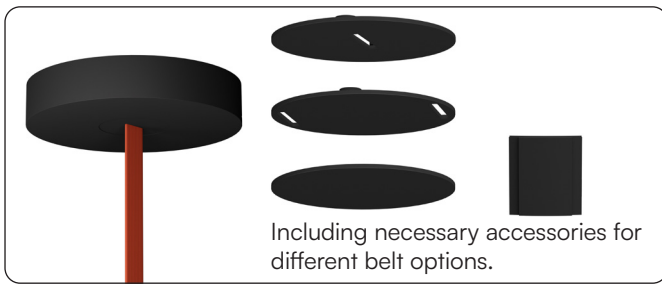

Surface Canopy



Recessed Canopy

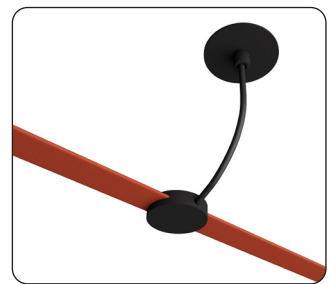

Recessed Wire Connector

5

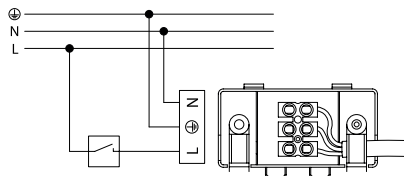
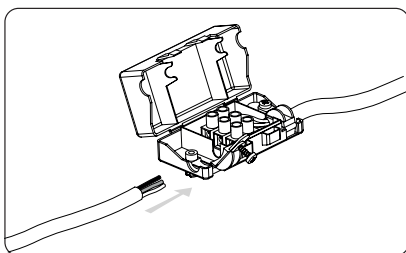
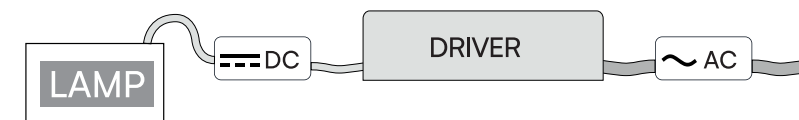

**CAUTION:** To avoid possible electrical shock, make certain electricity is shut off at main panel before wiring.

**INSTALLATION INSTRUCTIONS**

1. Switch off the power before installation.
2. Connect Luminaire to the belt.
3. Make sure to do the mechanical tension adjustment before and after attaching the luminaire.
4. Belt end to be connected to either Recessed/ Surface Canopy.
5. Connect the wires as per the diagram.
6. Switch on the power to test the light.

COMPLETE INSTALLATION INSTRUCTIONS CAN BE FOUND ON THE V-TAC WEBSITE  
& ARE ALSO ACCESSIBLE VIA THE PROVIDED QR CODE