



Meaningful Innovation.

WEEE Number: 80133970

INSTRUCTION MANUAL

LED DESIGNER HANGING LIGHT

TECHNICAL DATA

MODEL	VT-7765
SKU	6931
WATTS	12 W
LUMENS	1280 Lm
BEAM ANGLE	360°
BODY TYPE	Metal+Acrylic
INPUT POWER	AC: 180-240V, 50Hz
CRI	>80
IP RATING	IP20
LIFE SPAN	20,000 Hours
ON/OFF CYCLE	>15,000 Times
BASE SIZE	140x350 mm
DIMENSION	Ø240 x 500 mm



ADJUSTABLE HEIGHT

02 YEAR WARRANTY*

INTRODUCTION & WARRANTY

Thank you for selecting and buying V-TAC product. V-TAC will serve you the best. Please read these instructions carefully before starting the installation and keep this manual handy for future reference. If you have any another query, please contact our dealer or local vendor from whom you have purchased the product. They are trained and ready to serve you at the best. The warranty is valid for 2 years from the date of purchase. The warranty does not apply to damage caused by incorrect installation or abnormal wear and tear. The company gives no warranty against damage to any surface due to incorrect removal and installation of the product. This product is warranted for manufacturing defects only.

WARNING

1. Please make sure to turn off the power before starting the installation.
2. Installation must be performed by a qualified electrician.
3. The light source of this luminaire is not replaceable; when the light source reaches its end of life the whole luminaire shall be replaced.
4. Proper grounding should be ensured throughout the installation.
5. For Indoor Use only

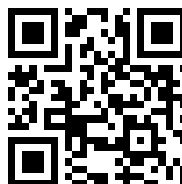

**MULTI-LANGUAGE
MANUAL QR CODE**

Please scan the QR code to access the manual in multiple languages.



This marking indicates that this product should not be disposed of with other household wastes.







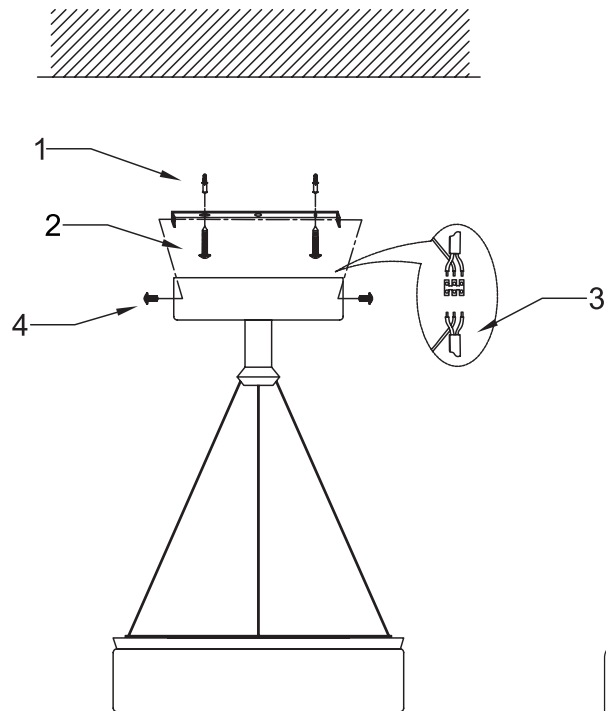

Caution, risk of electric shock.

In case of any query/issue with the product, please reach out to us at: support@v-tac.eu
For More products range, inquiry please contact our distributor or nearest dealers.
V-TAC EUROPE LTD. Bulgaria, Plovdiv 4000, bul.L.Karavelow 9B

INSTALLATION INSTRUCTION



WIRING DIAGRAM

	N		Neutral Supply can be Blue or Black
	⊕		Ground Supply Can be Green-yellow
	L		Live Supply Can be Red or Brown

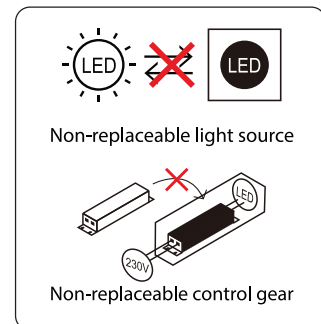

1. Switch off the power before starting the installation.
2. Use screws to fix mounting bar to the junction box.
3. Make the wire connections with connectors.
 - Connect the live wire (L) from fitting to the live wire from main power supply.
 - Connect the neutral wire (N) from fitting to the neutral wire from main power supply.
 - Connect the earth wire from fitting to the earth wire from main power supply.
 - Please pay close attention and make sure the wires are not exposed outside when wiring connections.
4. Use screws to fix canopy to mounting bar.
5. Check if the installation is completed and turn on the power.

Note: This light is designed with adjustable height, press the pin on the canopy to adjust the height of the light.

