



Meaningful Innovation.

WEEE Number: 80133970

INSTALLATION INSTRUCTION GALLERY - PENDANT (VT-7972)

TECHNICAL DATA

SKU	23362
MODEL	VT-7972
MAX RATED WATTS	40W
BASE	E27 (Bulb not included)
MATERIAL	ROPE
WIRE LENGTH	1 METER
IP RATING	IP20
INPUT VOLTAGE	AC: 220-240V, 50Hz



02 YEAR
WARRANTY*

INTRODUCTION & WARRANTY

Thank you for selecting and buying V-TAC product. V-TAC will serve you the best. Please read these instructions carefully before starting the installation and keep this manual handy for future reference. If you have any another query, please contact our dealer or local vendor from whom you have purchased the product. They are trained and ready to serve you at the best. The warranty is valid for 5 years from the date of purchase. The warranty does not apply to damage caused by incorrect installation or abnormal wear and tear. The company gives no warranty against damage to any surface due to incorrect removal and installation of the product. The products are suitable for 10-12 Hours Daily operation. Usage of product for 24 Hours a day would void the warranty. This product is warranted for manufacturing defects only.

WARNING!

1. Please turn off power and read this instruction before starting the installation.
2. Please turn power off before changing the bulb and cleaning the fixture.
3. Proper grounding should be ensured throughout the installation.
4. Installation should only be done by a certified electrician.
5. For Indoor Use only



This marking indicates that this product should not be disposed of with other household wastes.



Caution, risk of electric shock.

INSTALLATION DIAGRAM:

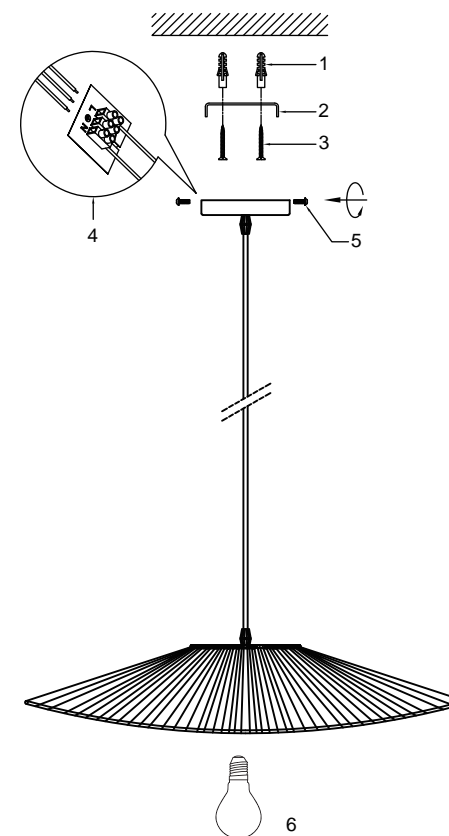

1. Use screws to fix mounting bar to the junction box.
2. Make the wire connections with connectors .
 - Connect the live wire (L) from fitting to the live wire from main power supply.
 - Connect the neutral wire (N) from fitting to the neutral wire from main power supply.
 - Connect the earth wire from fitting to the earth wire from main power supply.
 - Please pay close attention and make sure the wires are not exposed outside when wiring connections.
3. Use screws to fix canopy to mounting bar .
4. Use socket ring to fix shade to the socket.
5. Install the bulb (not included) at recommended wattage to the socket.
6. Check if the installation is completed and turn on the power.

